**User's
Manual**

User's Manual

Foreword

Thank you for purchasing the paperless recorder!

This manual is about the functions, settings, wiring methods, methods of operation, failure of treatment methods of the paperless recorder. To ensure correct use, please read this manual carefully and use properly before operation and keep this manual in a safe place for quick reference.

Notice

- The contents of this manual are subject to change without prior notice as a result of continuing improvements to the instrument's performance and functions.
- Every effort has been made in the preparation of this manual to ensure the accuracy of its contents. However, should you have any questions or find any errors, please contact us.
- Copying or reproducing all or any part of the contents of this manual without our permission is strictly prohibited.

Revisions

Fifth edition:	Dec. 2022
Fourth edition:	Oct. 2015
First edition:	March 2013

Safety Precautions

The following general safety precautions must be observed during all phases of operation. If the Instrument is used in a manner not specified in this manual, the protection provided by the Instrument may be impaired. We assume no liability for the customer's failure to comply with these requirements.

WARNING

- **Power Supply**
Before connecting the power cord, ensure that the power supply voltage matches the voltage rating for the instrument.
 - **Protective Grounding**
Make sure to connect the protective grounding to prevent electric shock before turning ON the power.
 - **Necessity of Protective Grounding**
Never cut off the internal or external protective grounding wire or disconnect the wiring of the protective grounding terminal. Doing so poses a potential shock hazard.
 - **Defect of Protective Grounding**
Do not operate the instrument when the protective grounding or the fuse might be defective. Also, make sure to check them before operation.
 - **Do Not Operate in Explosive Atmosphere**
Do not operate the instrument in the presence of flammable liquids or vapors. Operation of any electrical instrument in such an environment constitutes a safety hazard.
 - **Do Not Remove Covers**
Some areas inside the instrument have high voltages. Do not remove the cover if the power supply is connected. The cover should be removed by our qualified personnel only.
 - **External Connection**
Connect the protective grounding before connecting to the item under measurement or control unit.
 - **Damage to the protection**
Using the instrument in a manner not specified in this manual can damage the instrument's protection.
-

Checking the Contents of the Package

Unpack the box and check the contents before operating the instrument. If some of the contents are not correct or missing or if there is physical damage, contact the dealer from which you purchased them.

Main Unit

There is a name plate on the up side of the instrument's body. Open the cover and check that the model name and suffix code given on the name plate match those on the order.

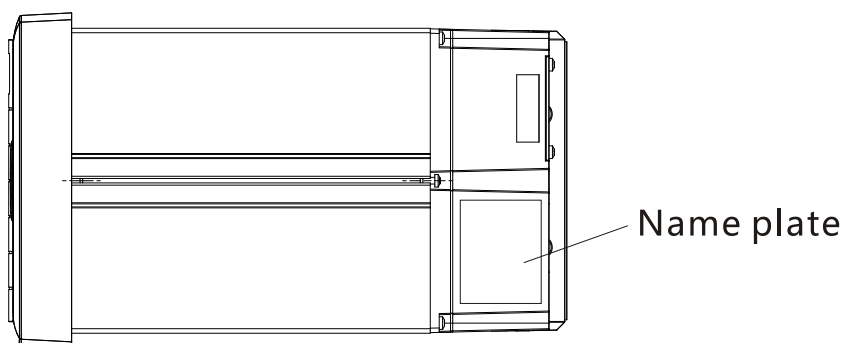

Standard Accessories

The following standard accessories are supplied with the instrument. Make sure that all items are present and undamaged.

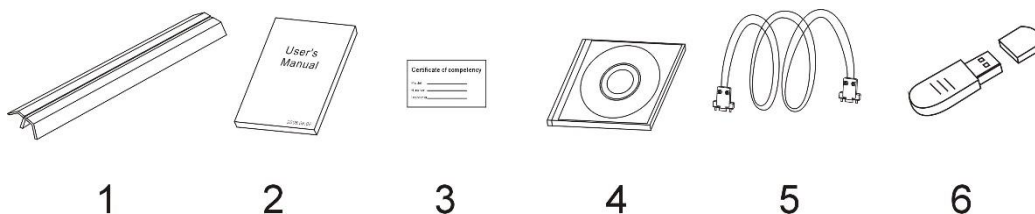

Number	Part Name	Qty	Notes
1	Mounting bracket	2	For panel mounting
2	User's Manual	1	Order
3	Certification	1	Manufacture Date
4	Software	1	Order
5	Communication Cord	1	1.5 meters Order
6	U Disk	1	Max: 32GB Order

Conventions Used in this Manual

Unit

K	Denotes"1024"
k	Denotes"1000"
M	Denotes"1024K"
G	Denotes"1024M"
B	"Bytes"

Symbols(The following symbols are used in this manual)

WARNING Describes precautions that should be observed to prevent injury or death to the user.

CAUTION Describes precautions that should be observed to prevent damage to the instrument.

Note Provides important information for the proper operation of the instrument.

Notation regarding procedures

The following symbols are used during the explanation of operation

[] Represent key's name. Example: [Page] [En]

〔 〕 Indicate a reference item. Example: 〔Input Channel Setting〕

Contents

Foreword	1
Chapter 1 Overview of Functions	1
1.1 Overview of the Instrument.....	1
1.2 Functions of the Input Section.....	2
1.3 Display Function.....	4
1.4 Storage Function.....	5
1.5 Alarm Function.....	6
1.6 Computation Function (Option).....	7
1.7 Analog Output Function (Option).....	7
1.8 Communication Functions (Option).....	7
1.9 24 VDC Power Supply for Transmitter (Option).....	7
Chapter 2 Before Using the Instrument	8
2.1 Precautions on the Use of the Instrument.....	8
2.2 Installing the Instrument.....	9
2.3 Input and Output Signal Wiring.....	11
2.4 Alarm Output Wiring (Option).....	14
2.5 Input Digital Signal Wiring (Option).....	16
2.6 Connect Power Supply.....	17
2.7 24VDC Transmitter Power Wiring(Option).....	19
2.8 RS232C/RS485 Communication Wiring.....	21
2.9 Connect Ethernet(Option).....	23
Chapter 3 Names of Parts/Run Mode/Common Operations	24
3.1 Names of Parts and Functions.....	24
3.2 Inserting/Removing the External Storage Medium.....	26
3.3 Run Mode.....	27
3.4 Common key operations.....	29
Chapter 4 Switching Operation Screens	31
4.1 Switching operation screens.....	31
4.2 Explanation of the status Display Section.....	32
4.3 PID screen.....	33
4.4 Overview screen.....	34
4.5 Bar Graph Display.....	35
4.6 Trend screen.....	36
4.7 History screen.....	38
4.8 Alarm summary.....	40
4.9 Report.....	41
Chapter 5 System Configurations	46
5.1 Setting Alias\Date\Language\Password\RJC.....	46
5.2 Setting Trend Direction and Groups of the Trend.....	47
5.3 Show/Hide the Run Screens.....	48
5.4 Setting Background Color.....	49
Chapter 6 Input Channel Settings	50
6.1 Input Parameter Setting.....	50
6.2 Reference Junction Compensation.....	54
6.3 Accumulation Setting.....	55
6.4 Copying Channel Parameters.....	56

Chapter 7	Virtual Channel Settings(Optional)	57
7.1	Virtual Channel Parameter Setting	57
Chapter 8	Setting Alarms	58
8.1	Alarm Setting	58
8.2	Setting the Relay Delay Period	60
Chapter 9	Setting Analog Outputs(Optional)	61
9.1	Analog Outputs Setting	61
Chapter 10	Data Saving and Saving to External Medium	62
10.1	Setting the Saving Interval of Internal Memory	62
10.2	Saving data and format USB(Optional)	63
Chapter 11	Setting Compensation Parameters(Optional)	64
11.1	Set Compensation Model and Channel Parameters	64
11.2	Set Compensation Model Parameters	66
Chapter 12	PID Function(Optional)	83
12.1	Setting specifications of PID	83
Chapter 13	Setting Report(Optional)	84
13.1	Setting specifications of report	84
Chapter 14	Communication Function(Optional)	85
14.1	Setting Device Address	85
14.2	Setting COM Parameters	86
14.3	Modbus-RTU protocol	87
14.4	Setting Ethernet Parameters	88
14.5	Modbus/TCP protocol	89
14.6	Register address of the instrument	90
Chapter 15	Set Printing Configuration(Optional)	91
15.1	Connect with Micro Printer(Optional)	91
15.2	Auto Print Function Setting	92
Chapter 16	System Information and Upgrade	93
16.1	Check System Information	93
16.2	Upgrade	94
Chapter 17	Initializing Data	95
17.1	Restore Factory Setting	95
17.2	Purge Alarm Summary	97
17.3	Purge Accumulation Data	98
Chapter 18	Specifications	99
18.1	Signal and Alarm Specifications	99
18.2	Display Specifications	101
18.3	Data Storage Specifications	102
18.4	Other standard functions	102
18.5	Select fittings	103
18.6	General Specifications	104
18.7	Dimensional Drawings	106

Chapter 1 Overview of Functions

1.1 Overview of the Instrument

Unlike conventional record that record data on charts, the Instrument displays the measured data acquired in the internal memory to a LCD in the form of waveforms, numerical values, and bar graphs. The measured data can also be saved to external storage media such as U Disk.

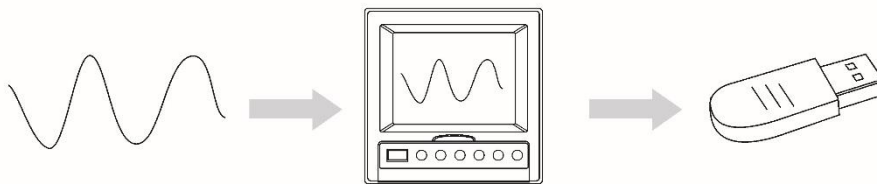

The data that have been saved to an external storage medium can be displayed on a PC using the standard software that comes with the package.

By using the RS232C or RS485 interface that comes standard with the Instrument, the data can be transferred to a PC (client function).

1.2 Functions of the Input Section

Number of Measurement Channels/Scan Interval

The number of measurement channels can be selected from 1~16.
 The scan interval of measurement is 1 second.

Input Type and Computation

You can select the input type of a measurement channel as follows. You can also perform computation on the measured data such as the “square root,” and “small signal cutting.”
 For the procedure related to setting the different modes, see section 『System Configurations』

Input Mode	Signal Type
DC current	0-10mA 4-20mA
DC voltage	0-20mV 0-100mV 0-5V
Resistance	0 - 400Ω
Thermocouple	S, B, K, T, E, J, R, N, F1, F2, WRE
RTC	PT100, Cu50, BA1, BA2
frequency	0 - 10000Hz

Input Range and Measurable Range

You can select the “Input range” that is appropriate for the input signal for “DC current,” “DC voltage,” “Resistance,” “Thermocouple,” “RTD,” and “Frequency.” For each “Input range,” a measurable range is defined.

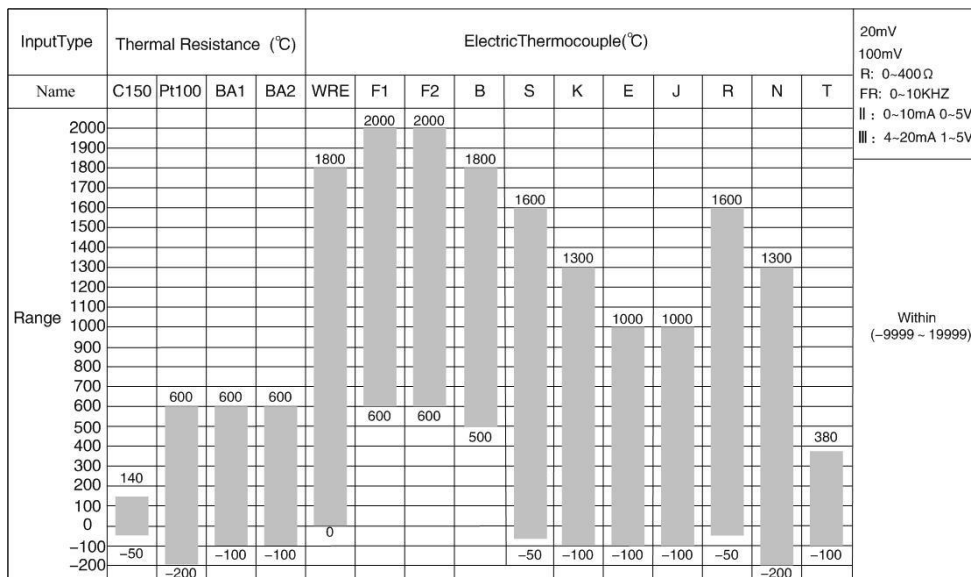

Burnout

When measuring temperature with a thermocouple / thermal resistance / 4-20mA / 1-5V signal, the instrument provides check burnout function. You can specify the measurement result to be set to maximum of measurable range, minimum of measurable range, last value or Error Flag*1. For the setting procedure, see section 『Burnout』 .

*1 when the burnout setting is Error Flag, the measured value is indicated as “#####”.

Reference Junction Compensation (RJC)

When measuring the temperature using a thermocouple, the reference junction compensation can be used. Reference junction compensation current is installed. You can adjust the temperature that measured by the instrument. For the setting procedure, see section 6.6.

Filter

The filter is used to suppress the effect noise that is riding on the signal. Filtering is provided on the standard products. The filter can be set on each channel. For the setting procedure, see section 6.4.

1.3 Display Function

Common Items Related to the Display
TFT Color LCD and the Screen Configuration

The instrument has a 5.6" TFT color LCD (234-by-320 dot resolution). The screen consists of the status display section and the data display section.

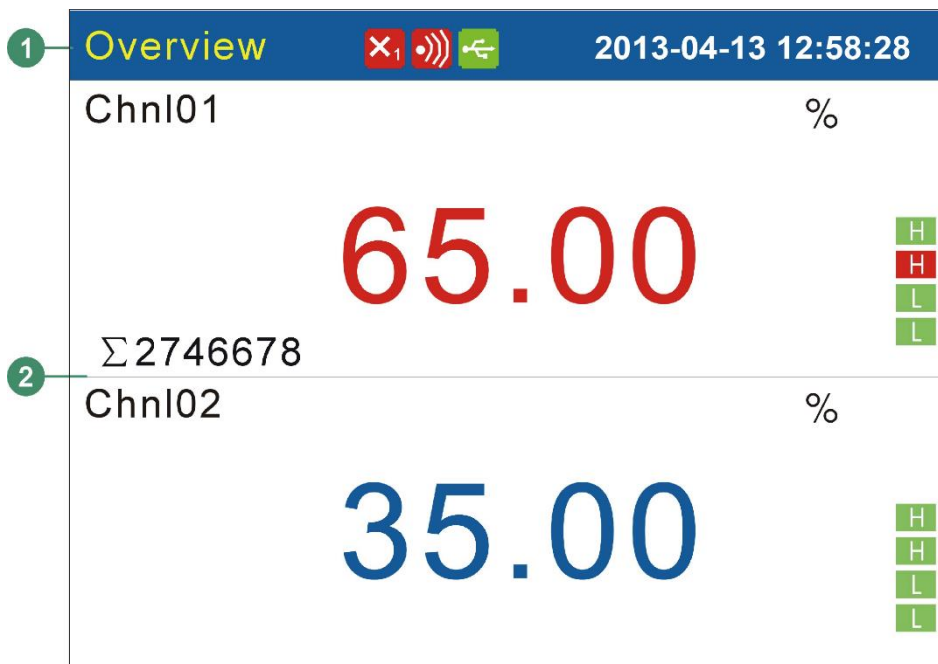

Status Display Section

Display the displayed screen name, date and time, I/O boards running condition, alarm condition, USB device condition (option), cycle display condition, and history trend condition. For details, see section 4.2.

Data Display Section

Display the operation screen such as the trend display, digital display, and bar graph display of the measured and alarm summary, print operation, and backup operation.

Display the setup screen for the setting mode when the Instrument is being configured. For details related to the setting mode, see section 3.4.

Group Display

The data displayed on the trend displays are the data of measurement or computation channels that are assigned to the group. Up to 4 channels can be assigned to a single group. For the procedure used to assign channels to groups, see section 5.4. Up to four groups can be registered. The groups are common to the trend displays. On the trend displays, the displayed groups can be automatically switched at 10s intervals.

Run Mode

This mode is used for daily operation.

This mode is entered when the power is turned ON.

Displays various operation screens such as digital, bar graph, trend, historical trend, alarm summary, data print(option), and data backup display (option). Screens are switched by the PAGE key.

Setting Mode

The various functions of the instrument are configured using the setting mode.

This screen is used to set the input range, filter, alarm, group, etc.

1.4 Storage Function

The measured/computed data are first acquired to the instrument's internal memory as display data. Then, the data are saved to the external storage medium manually when the external storage medium is inserted into the drive.

The capacity of the internal memory for acquiring display data is 6 MB. For detail, see sections 『 Date Saving and Saving to External Storage Medium 』

External Storage Media and Internal Memory

The capacity of the internal memory for acquiring display data is 6 MB.

Various data can be saved to the U disk.

Scan Interval and Saving Interval

The scan interval of signal is fixed at 1s. The measuring and computing are completed in every scan interval. Display data is generated by these data.

All measured or computed data sampled can be saved to internal memory by saving interval.

Saving Data to Internal Memory

The display data are saved to internal memory continuously by saving interval.

If the instrument is unplugged, the data that lost while unplugged will be complemented by '0' when the power is turned ON.

Saving Data to External Storage Media

Insert the storage medium to the drive when data is to be saved (referred to as manual save).

1.5 Alarm Function

This function generates an alarm when the measured/computed data meets a certain condition. When an alarm occurs, information notifying the alarm occurrence is displayed on the screen. In addition, a signal can be output from the relay output terminals on the rear panel of the instrument (Option). For details, see section 『Setting Alarms』.

Alarm Indication

The alarm conditions are displayed as alarm icons in the status display section and through the trend, bar graph, overview and other screens. The detailed information about the alarms is displayed in the alarm summary.

Number of Alarms

You can set up to four alarms for each channel.

Alarm Conditions

The following eight conditions are available:

- High-high alarm (HH)

An alarm occurs when the measured value exceeds the alarm value.

- High alarm (H)

An alarm occurs when the measured value exceeds the alarm value.

- Low alarm (L)

An alarm occurs when the measured value falls below the alarm value.

- Low-low alarm (LL)

An alarm occurs when the measured value falls below the alarm value.

Alarm Hysteresis

This applies to ultra-upper (HH), upper (H), lower (L) and ultra-lower (LL) limit alarms on measurement channels. A width (hysteresis) can be specified on the value used to set or release the alarm. This prevents the alarm from being set or released repetitively when the measured value is fluctuating around the alarm value. About setting the hysteresis, see section 7.2.

Alarm Output Relay

If you are using a model with the optional alarm output relay, a contact signal can be generated according to the alarm conditions. For the procedure related to setting the alarm output relay, see section 7.2, “Alarm Setting.” For details, see section 7.1.

Delay Alarm

An alarm occurs when the measured value remains above or below the alarm value for the specified time period (delay period).

1.6 Computation Function (Option)

The Accumulation computation can be performed.

Accumulation Computation

The accumulation computation is performed every second.

The accumulation computation can be performed on each measurement channel.

For detail, see section 『 Accumulation Setting 』

1.7 Analog Output Function (Option)

Measured and Computed data can be transmitted and output as an analog signal.

Transmitter Output

The signal type of transmitter output is 4-20mA.

The instrument provides 4 channels transmitter output. The maximum load of each channel can be drover is 750Ω.

For detail, see section 『 Analog Outputs Setting 』

1.8 Communication Functions (Option)

The instrument can communicated with PC via serial cable. And also can print data or trend by micro printer.

RS232C/RS485 Interface

RS232C or RS485 can be select when the instrument communicates with PC.

By using the MODBUS-RTU protocol, measured/computed data written to the instrument's input register can be read by the PC.

The OPC software also provides for users, you can use it to connect the general HMI software like iFix, inTouch. Etc.

Ethernet

RJ45 can be select when the instrument communicates with PC.

By using the Modbus/TCP protocol.

Micro Printer

History Data, History Trend and Display Data can be printed using micro printer.

You can print history data and history manually.

Print display data will be automatic.

1.9 24 VDC Power Supply for Transmitter (Option)

Provide 24 VDC power to transmitters.

The instrument provides 4 channels power supply. The maximum current of each channel can be provided is 60mA.

Chapter 2 Before Using the Instrument

2.1 Precautions on the Use of the Instrument

Read the following precautions before using the instrument and the external storage medium (U disk).

Handling Precautions

- Be careful when cleaning the instrument, especially any plastic parts. When cleaning, wipe with a dry, soft cloth. Do not use chemicals such as benzene or thinner, since these may cause discoloring and deformation.
- Keep electrically charged objects away from the instrument as this may cause malfunction.
- Do not apply volatile chemicals to the LCD monitor or panel keys. Do not allow rubber and vinyl products to remain in contact with the instrument for long periods of time. This may damage the instrument.
- Do not apply shock to the instrument.
- When not in use, make sure to turn OFF the power switch.
- If there are any symptoms of trouble such as strange odors or smoke coming from the instrument, immediately turn OFF the power and unplug the power cord. Then, contact your dealer or us.

Handling precautions of external storage media

- Take special care in handling external storage media as they are delicate products. For general precautions, see the instruction manual that came with the external storage medium.
- U disks may not operate properly under high or low temperature environment. If you are using the instrument in a low-temperature environment (less than 10 °C), let the instrument warm-up for at least 30 minutes beforehand.
- If you are using them in a high-temperature environment (greater than 40 °C), we recommend the external storage medium be inserted into the drive when saving the data and be removed after the data have been saved.
- Remove the external storage medium from the drive when turning ON/OFF the instrument.
- Do not remove the external storage medium while the access lamp is lit. Doing so can destroy the data on the medium.
- If you are using a commercially available U disk on instruments in the USB port, be careful of static electricity. The instrument may not operate properly if you touch the U disk that is inserted into the instrument when your body is charged with static electricity.

2.2 Installing the Instrument

Installation location

Install the instrument in a location that meets the following conditions.

- Instrument panel
The instrument is designed for panel mounting.
- Well-ventilated location
To prevent overheating, install the instrument in a well-ventilated location. For the panel mount type, see section 『Dimensional Drawings』
- Minimum mechanical vibrations
Choose an installation location with the minimum mechanical vibration.
- Horizontal
Install the instrument horizontally (However, the instrument can be inclined up to 30 degrees backwards for panel mounting).

Note

- Condensation may occur if the instrument is moved to another place where both the ambient temperature and humidity are higher, or if the temperature changes rapidly. In addition, measurement errors will result when using thermocouples. In this case, let the instrument adjust to the new environment for at least one hour before using the instrument.
 - The lifetime of the LCD may be shortened if the instrument is used in a high-temperature environment over a long period of time. When installing the instrument in a high-temperature environment (greater than 40°C), we recommend the backlight brightness of the LCD be set to a low setting.
-

Do not install the instrument in the following places:

- In direct sunlight or near heat sources
Install the instrument in a place with small temperature fluctuations near room temperature (23 °C). Placing the instrument in direct sunlight or near heat sources can cause adverse effects on the internal circuitry.
- Where an excessive amount of soot, steam, moisture, dust, or corrosive gases are present
Soot, steam, moisture, dust, and corrosive gases will adversely affect the instrument. Avoid such locations.
- Near strong magnetic field sources
Do not bring magnets or instruments that produce electromagnetic fields close to the instrument. Operating the instrument in strong magnetic fields can cause errors in the measurements.
- Bad angle for viewing the screen
Because the instrument uses a 5.6" TFT color LCD, it is difficult to view the display from an extreme angle. Please install the instrument so that the monitor can be viewed from the front.

Installation Procedure (Panel MountType)

The instrument should be mounted on a steel panel of thickness 2 mm to 26 mm.

1. Insert the instrument from the front side of the panel.
2. As shown in the figure below, mount the instrument to the panel using the mounting brackets that came with the package.
3. Use two brackets to support the top and bottom sides of the case.

Panel Mounting

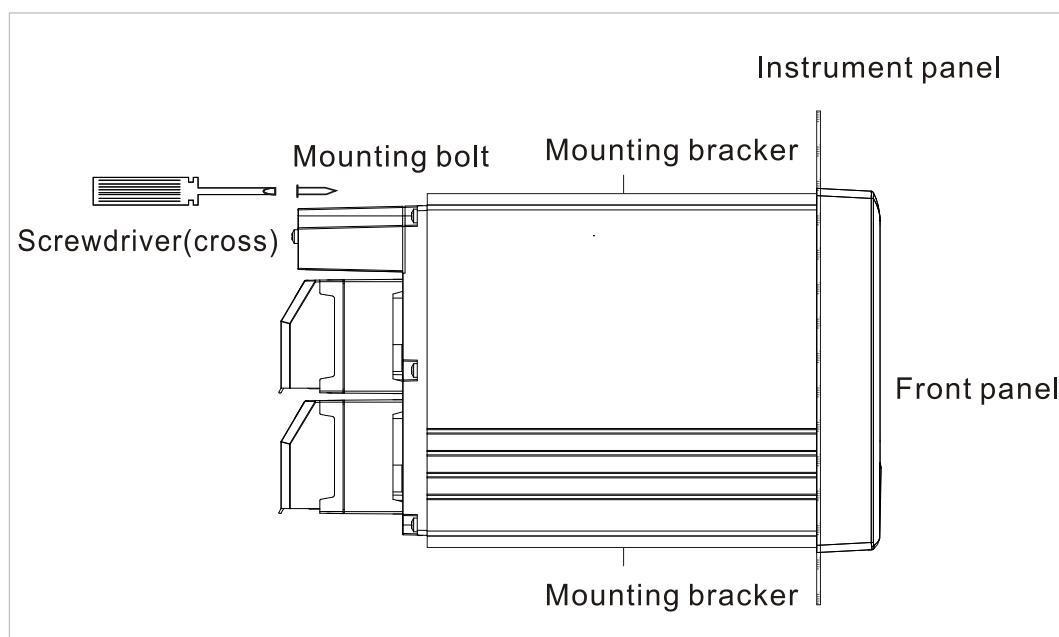
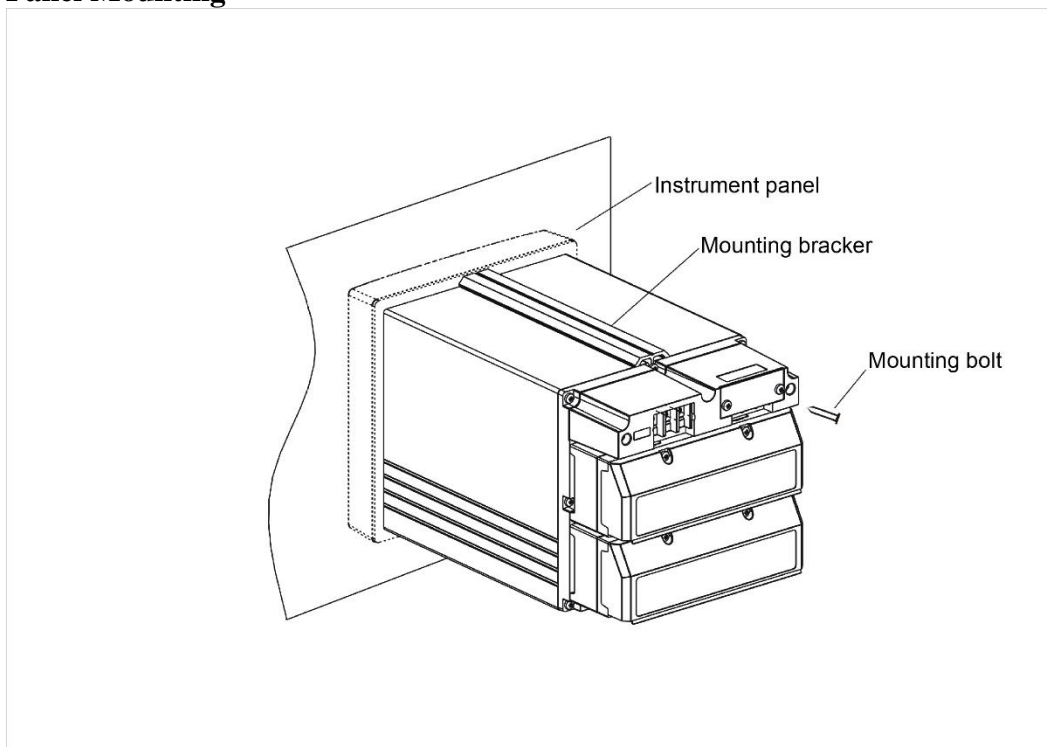

2.3 Input and Output Signal Wiring

CAUTION

If a strong tension is applied to the cable wired to the instrument, the terminals of the instrument and/or the cable can be damaged. In order to prevent tension from being applied directly on the terminals, fasten all wiring cables to the rear of the mounting panel.

Precautions to be taken while wiring

Take the following precautions when wiring the input signal cables.

It is recommended that crimp-on lugs (designed for 4 mm screws) with insulation sleeves be used on the lead wire ends.

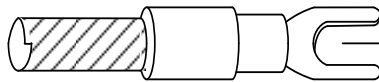

crimp-on lugs (designed for 4 mm screws) with insulation sleeves be used on the lead wire ends.

Take measures to prevent noise from entering the measurement circuit.

- Move the measurement circuit away from the power cable (power circuit) and ground cable.
- It is desirable that the item being measured does not generate noise. However, if this is unavoidable, isolate the measurement circuit from the item. Also, ground the item being measured.
- Shielded wires should be used to minimize noise caused by electrostatic induction. Connect the shield to the ground terminal of the instrument as necessary (make sure you are not grounding at two points).
- To minimize noise caused by electromagnetic induction, twist the measurement circuit wires at short, equal intervals.
- Make sure to earth ground the protective ground terminal through minimum resistance (less than 100 Ω).

When using the thermocouple input, take measures to stabilize the temperature at the input terminal.

- Always use the input terminal cover.
- Do not use thick wires which may cause large heat dissipation (cross sectional area 0.5 mm² or less recommended).
- Make sure that the ambient temperature remains reasonably stable. Large temperature fluctuations can occur if a nearby fan turns ON or OFF.

Connecting the input wires in parallel with other devices can cause signal degradation, affecting all connected devices.

If you need to make a parallel connection, then

- Ground the instruments to the same point.
- Do not turn ON or OFF another instrument during operation. This can have adverse effects on the other instruments.
- RTD cannot be wired in parallel.

WARNING

To prevent electric shock, ensure the main power supply is turned OFF.

CAUTION

Do not apply input signals that exceed the following values. This can damage the instrument.

4. Maximum input voltage

Voltage range of 0.2 VDC or less or thermocouples: ± 5 VDC

Voltage range between 2 and 10 VDC: ± 12 VDC

5. Maximum common mode noise voltage

250 VACrms (50Hz)

Wiring Procedure

1. Turn OFF the instrument and remove the input terminal cover.
2. Connect the input signal wires to the input terminals.
3. Replace the input terminal cover and fasten it with screws.

NOTE

- For clamped input terminals, the following wires are recommended.
Cross sectional area of the conductor or conductors
 - Single conductor: 0.14 mm² to 1.5 mm²
 - Stranded conductors: 0.14 mm² to 1.0 mm²
Stripped cable length: approximately 5 mm
 - Input signal wires of diameter less than or equal to 0.3 mm may not be secured firmly for clamped input terminals. Fold over the conducting section of the wire, for example, to make sure that the wire is securely connected to the clamped input terminal.
-

Signal Terminal Position

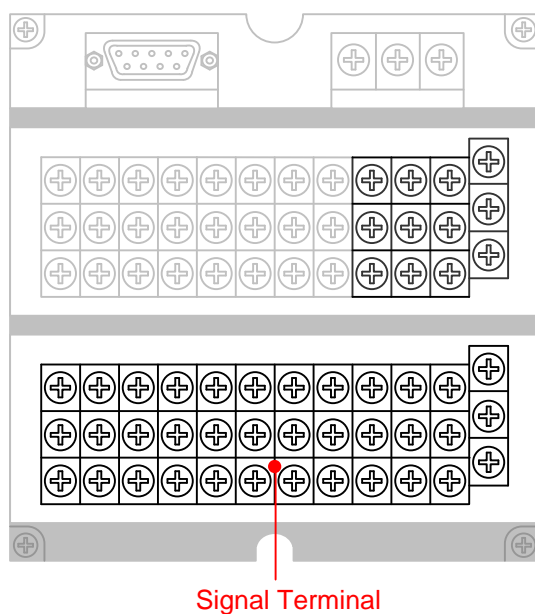

Terminal Arrangement

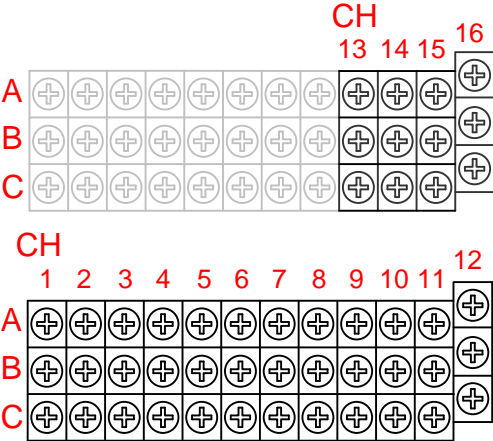

Wiring Diagram

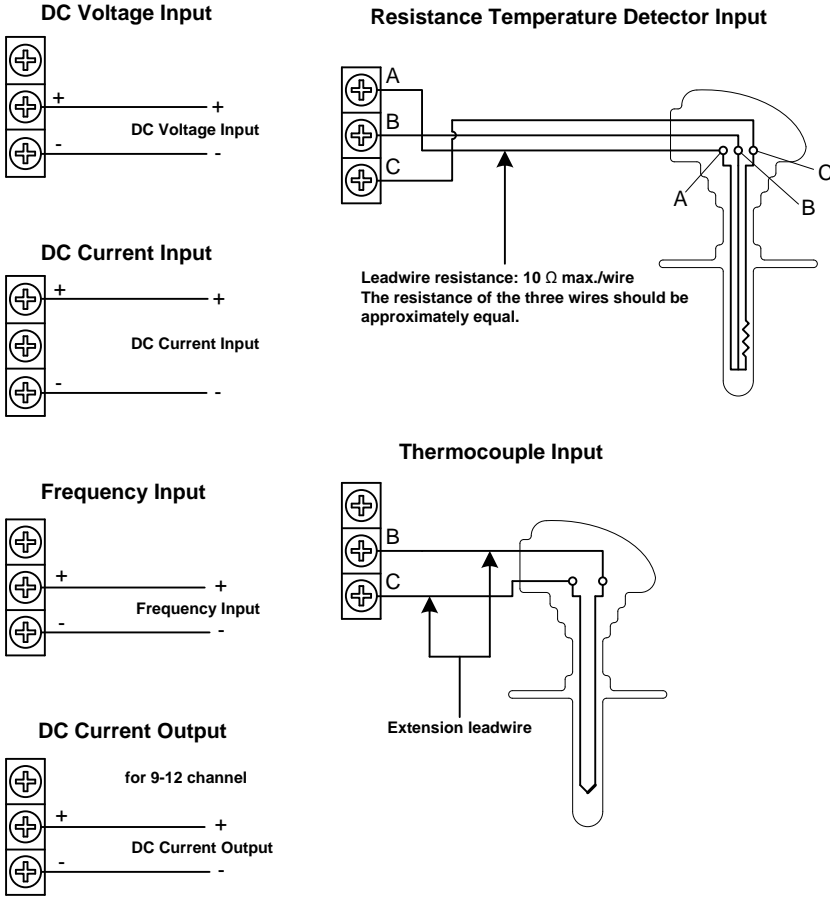

2.4 Alarm Output Wiring (Option)

WARNING

- To prevent electric shock, ensure the main power supply is turned OFF.
- If a voltage of more than 30 VAC or 60 VDC is to be applied to the alarm output terminal, use ring-tongue crimp-on lugs with insulation sleeves on all terminals to prevent the wires from slipping out when the screws become loose. Furthermore, use double-insulated wires (dielectric strength of 2300 VAC or more) for the signal wires on which a voltage of more than 30 VAC or 60 VDC is to be applied. For all other wires, use basic insulated wires (dielectric strength of 1350 VAC). To prevent electric shock, attach the terminal cover after wiring and make sure not to touch the terminals.

Wiring Procedure

Turn OFF the instrument and remove the cover for the option terminal.

Connect the alarm output cables to the terminal.

The terminal arrangement will be one of the figures shown on the next page depending on the alarm output relay option (number of outputs).

Replace the terminal cover and fasten it with screws.

CAUTION

To prevent fire, use signal wires having a temperature rating of 70°C or more.

Alarm Terminal Position

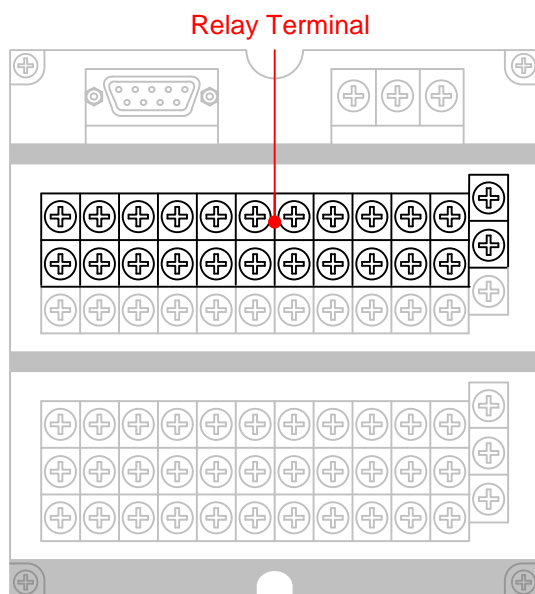

Normally open alarm relay contact arrangement

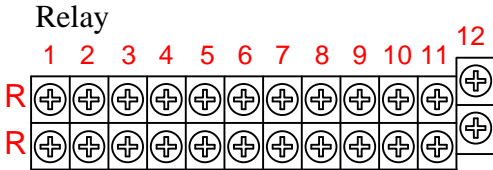

Note: If the channel number is more than 12, then the largest contact number is 8, and contact terminal from 9 to 12 is used as signal input terminal in channel 13 to 16.

Normally closed alarm relay contact arrangement

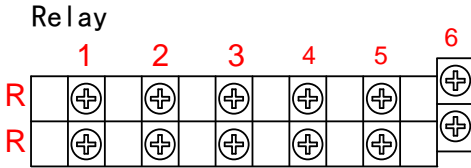

Wiring diagram

Normally open alarm relay

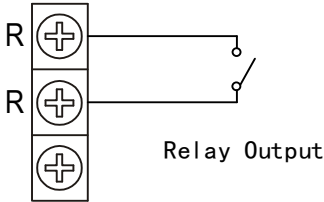

Normally closed alarm relay

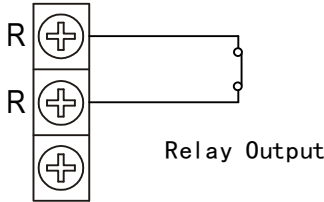

Contact Specifications

Item	Specification
Output Type	Relay transfer contact (energize/de-energize switchable)
Output capacity	250 VAC (50 Hz), 3 A 30 VDC, 3 A (resistive load)
Dielectric strength	500 VAC (50 Hz) for one minute between output terminals and the ground terminal

2.5 Input Digital Signal Wiring (Option)

Wiring Procedure

1. Turn OFF the instrument and remove the cover for the option terminal.
2. Connect the alarm output cables to the terminal.
3. Replace the terminal cover and fasten it with screws.

CAUTION

To prevent fire, use signal wires having a temperature rating of 70°C or more.

Digital Input Terminal Position

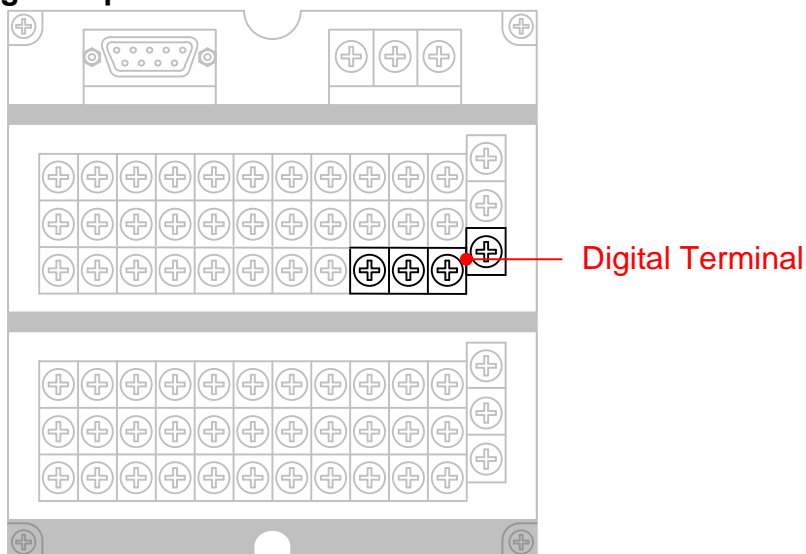

Terminal Arrangement

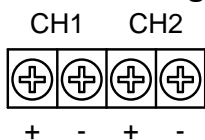

Contact Specifications

Item	Specification
Input signal	Voltage-free(dry)contact, open-collector(TTLor transistor)
Input conditions	Signal width: above 250ms Input voltage: ON: 4VDC – 24VDC OFF:0VDC – 1VDC
Input type	Opto-couplerisolation(one side common) Internal isolation power source (24VDC±5%)
Dielectric strength	30VDC for one minute between input terminals and the ground terminal.

2.6 Connect Power Supply

Precautions to be taken when wiring the power supply

To prevent electric shock and damage to the instrument, observe the following warnings.

WARNING

- To prevent electric shock, ensure the main power supply is turned OFF.
- To prevent the possibility of fire, use 600 V PVC insulated wire (AWG18) or an equivalent wire for power wiring.
- Make sure to earth ground the protective earth terminal through a grounding resistance less than 100 Ω before turning ON the power.
- Use crimp-on lugs (designed for 4mm screws) for power and ground wiring termination.
- Make sure to provide a power switch (double-pole type) on the power supply line in order to separate the instrument from the main power supply. Put an indication on this switch as the breaker on the power supply line for the instrument.

Switch Specification Rated current: 3A or more

- Connect a fuse (between 2A and 15A) to the power line.

Wiring Procedure

Connect the power supply wires and the protective ground wire to the power terminals.

Replace the terminal cover and fasten it with screws.

The position of power terminal:

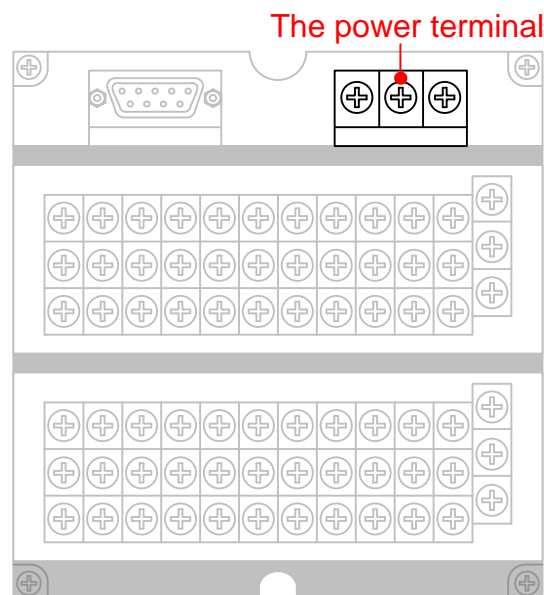

Terminal Arrangement

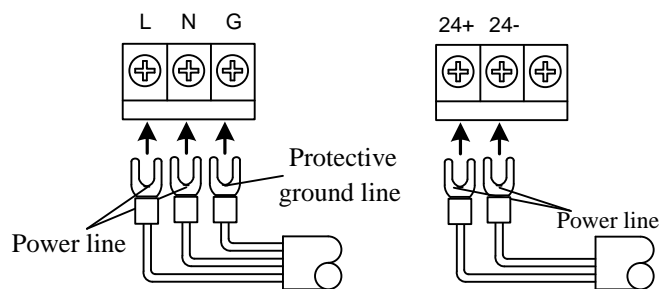

Contact Specifications

Power Supply	Specification
220V	Input voltage:85VAC ~ 265VAC Input frequency:50Hz ~ 60Hz
24V	Input voltage:24VDC

2.7 24VDC Transmitter Power Wiring(Optional)

Transmitter power output

CAUTION

Never short-circuit the power supply terminals or apply an external voltage, otherwise damage to the instrument may result.

Wiring Procedure

Turn OFF the instrument and remove the cover for the option terminal.
Connect the alarm output cables to the terminal.
Replace the terminal cover and fasten it with screws.

Note

Remove the cover for the option terminal can be expediently to wiring. To prevent contact badness, replace the terminal cover and fasten it with screws.

Transmitter Power Output Terminal Position

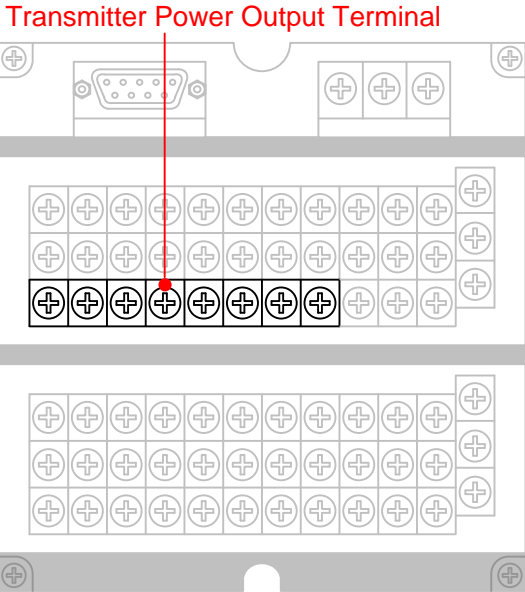

Terminal Arrangement

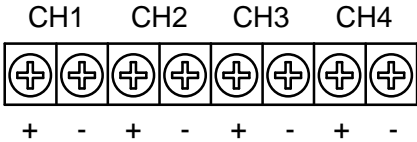

Wiring Diagram

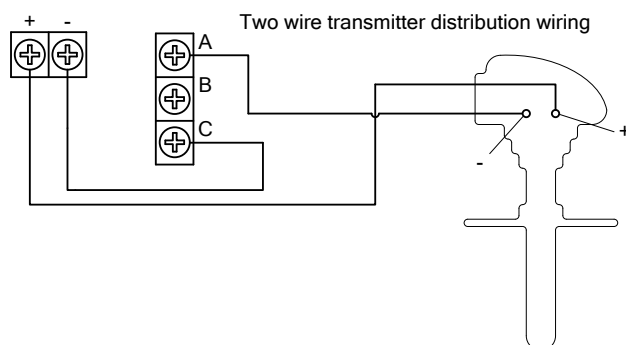

24VDC Transmitter Power Supply

Loop	4
Output voltage	22VDC ~ 25VDC(rate output current)
Maximum output current	65mADC(over-loading protect current: about 90mADC)
Maximum output current	$RL \leq (17 - \text{minimum circulate voltage})/0.02A$
There into	$RL \leq 750\Omega$ $17V = 22V - 5V$ 22V:Minimum output voltage 5V:Maximum voltage drop(shunt resistance 250 Ω)

2.8 RS232C/RS485 Communication Wiring

Here explains RS232C/RS485 communication wiring. Be sure to read this part before connecting.

Wiring Procedure

RS232C Communication wiring position in the rear instrument.

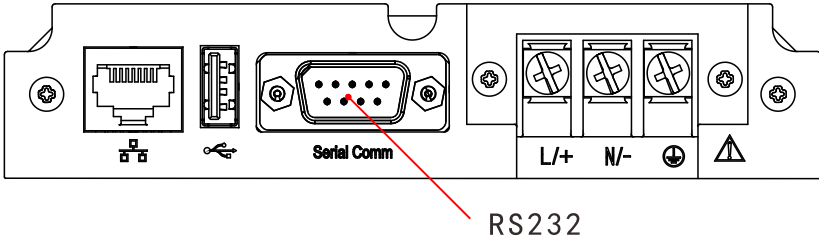

Pin	Signal Name	Description
2	RXD	Receive data from the RS232 interface, and the instrument input signal
3	TXD	Send data to the RS232 interface, and the instrument output signal
5	GND	Signal Ground

RS232C connection

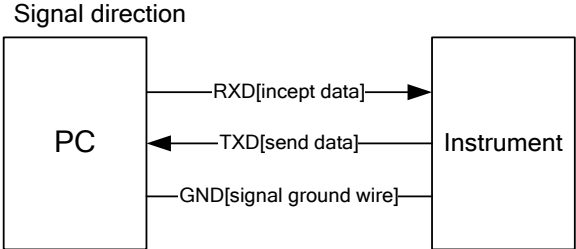

RS485's position in the rear instrument

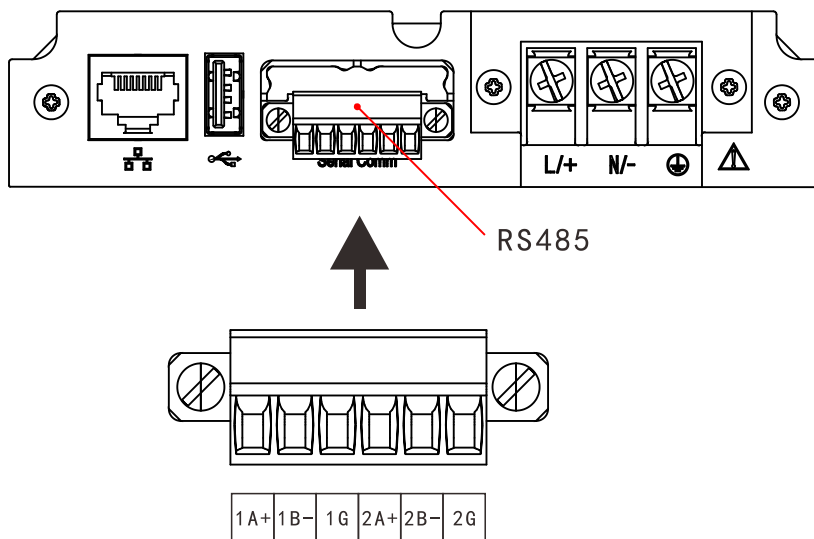

Pin	Description
1A+	The first RS485 communication A+
1B-	The first RS485 communication B-
1G	The first RS485 communication ground
2A+	The second RS485 communication A+
2B-	The second RS485 communication B-
2G	The second RS485 communication ground

RS485connection

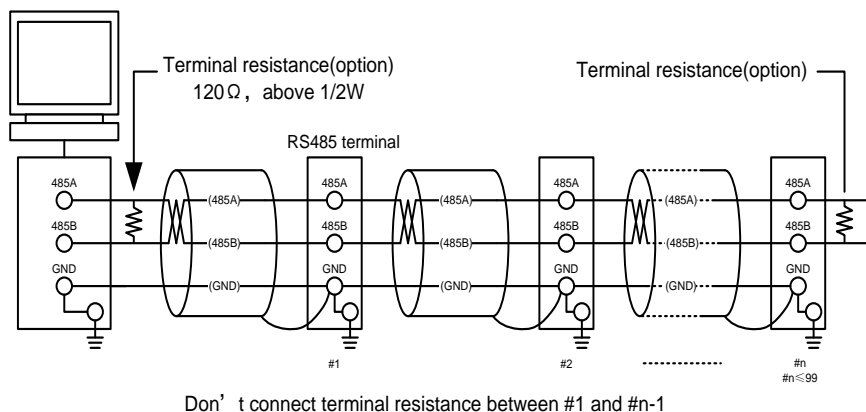

Communication Specifications

Item	Content
Speed(baud rate)	1200/2400/4800/9600/19200/38400/57600/115200
Data format	Eight data bits, One stop bit Optional checkout code(None/odd/even)

2.9 Connect Ethernet(Optional)

Here explains Ethernet communication wiring. Be sure to read this part before connecting.

Wiring Procedure

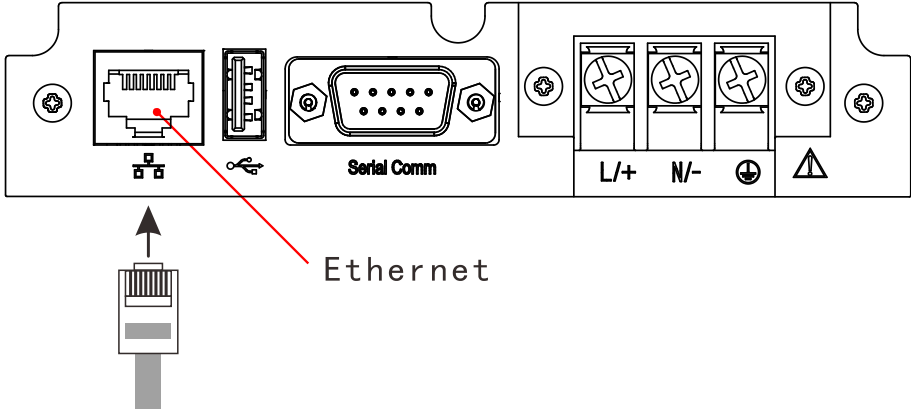

Use network cable connector to connect RJ45 connector.

For Ethernet parameter setting, please refer to the communication parameter setting section.

Communication Specification

Item	Content
Specification	10Base-T

Chapter 3 Names of Parts/Run Mode/Common Operations

3.1 Names of Parts and Functions

Front Panel

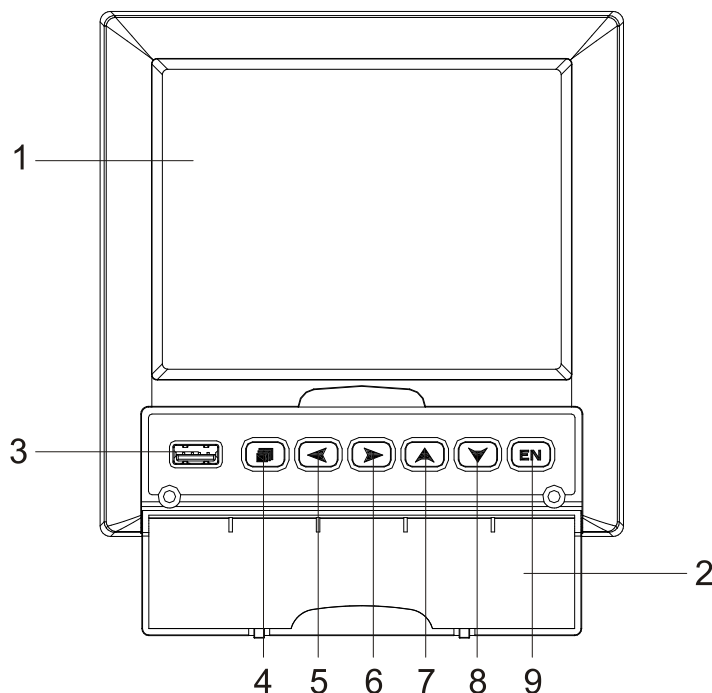

- 1. LCD Screen**
Display various operation screens such as the trend display and the setup screen to configure the instrument.
- 2. Front Cover**
Open this cover to access the keys or inserting or removing the external storage medium such as the USB disk. Open the cover by catching the center of the top edge of the cover and pulling it toward you.
Keep the cover closed at all times except when accessing the keys and the external storage medium.
- 3. USB Port**
USB Port is used to insert or remove the external storage medium such as the U disk.
- 4. PAGE key**
Used to switching operation display. Press this key down with ENTER key at the same time will becoming a combination key, used to enter the setting mode.
- 5. LEFT key**
Used to move cursor (blue) to left in run mode and setting mode. In continues mode of the history trend screen, used to scrolls the waveform along the time axis.
- 6. RIGHT key**
Used to move cursor (blue) to right in run mode and setting mode. In continues mode on history trend display, used to scrolls the waveform along the time axis.

7. UP key

Used to increase the value that cursor indicated, and switches groups on the trend screen.

8. DOWN key

Used to decrease the value that cursor indicated, and switches compress ratio on the history trend screen.

9. ENTER key

Used to execute the function of button that cursor indicated. It also display the input keypad when the value that cursor indicated can be edited. On history trend screen, you can switch replay mode between continuous time mode and select time mode.

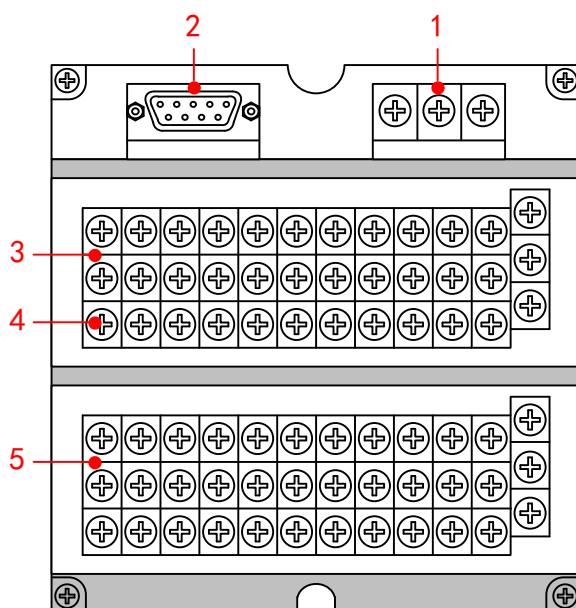
Rear Panel**1. Power terminals**

Connect the power cord.

2. RS232 Port and RS485 Port

RS-232 port or RS485 port depend on the specification. Connect the interface cable.

3. Relay terminals

Connect the relay output cable.

4. 24 VDC Power Supply for Transmitter

Provide 24 VDC power to transmitters.

5. I/O signal terminals

Connect the input signal cable of the item being measured or output signal cable.

Note: For the details, please refer to 『Before using the instrument』 chapter.

3.2 Inserting/Removing the External Storage Medium

This section describes the procedures to insert and remove the external storage medium. USB disk is the only type of media can be used.

For the handling procedure of the storage medium, see section 9.2.

Procedure

Inserting the storage medium

1. Open the front cover. Insert the U disk into the USB port.
2. The instrument detects the existence of an external storage medium in the drive automatically. If the storage medium is detected, an external storage medium icon is displayed in the status display section of the screen.
3. Press PAGE key to display Backup screen, saving data to U disk. Success information will be displayed when backup ended.

CAUTION

- Keep the front cover closed during operation except when accessing the external storage medium. This will protect the storage medium and the drive from foreign particles such as dust.
 - Keep the metal face upper when inserting the U disk, otherwise can't insert.
 - If you are using a commercially available U disk, be careful of static electricity.
-

Removing the storage medium

If the instrument is turned ON, check that the storage medium is not being accessed.

CAUTION

- The access lamp is lit while the storage medium is being accessed.
 - A message "Data are being saved to the medium." is displayed while data are being saved to the medium.
-

Specification

Formatting external storage media

Format the external storage medium before use.

Please use the PC to carry on the formatting for the USB flash drives, this product doesn't provide the formatted function.

Option

Parameters	Item
USB port	The USB 2.0 agreement
Content	Maximum 4GB

3.3 Run Mode

There are two run modes: operating and setting. This section describes the functions and relationships of the two modes.

Mode Types

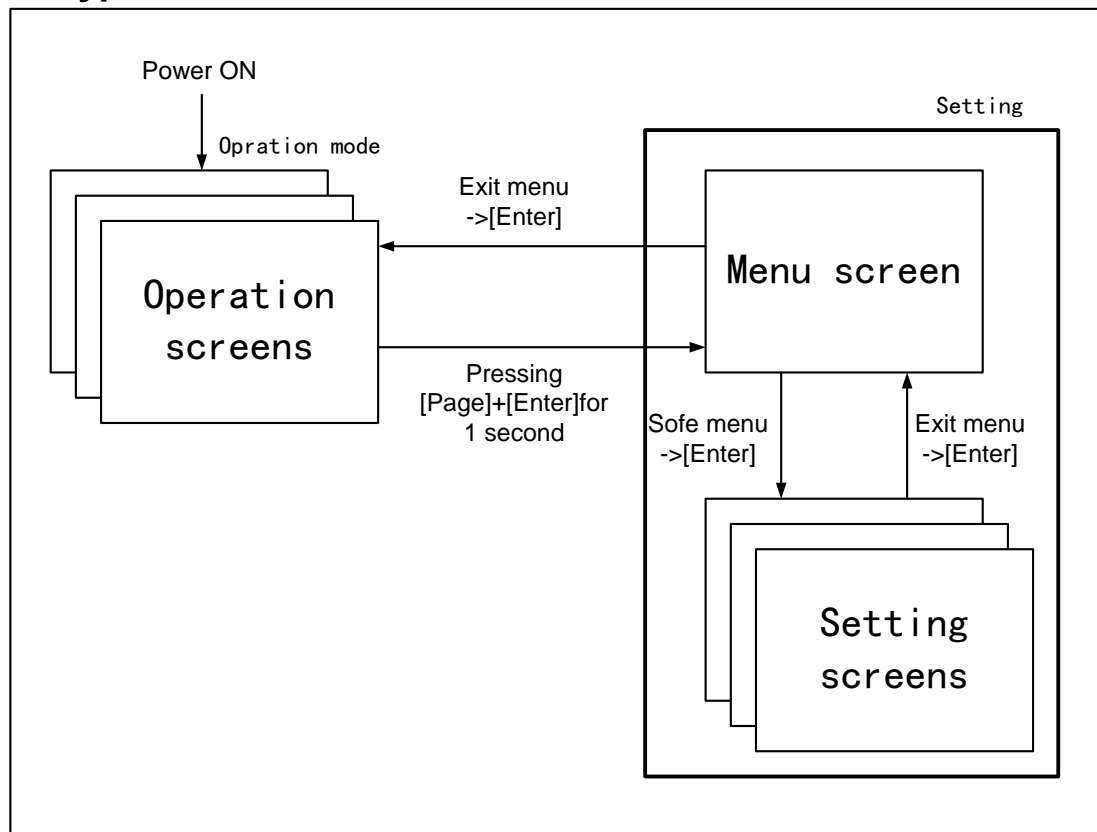

Mode Type	Description	Possible operations
Operation Mode	This mode is used for daily operation. This mode is entered when the power is turned ON. Back up data to the external storage.	Monitoring operation Dataacquisition Data printing Operation related to the file on the external storage medium.
Setting Mode	This mode is used to configure the operation such as input range and alarms. This mode is entered by pressing the [Page] and [Enter] key for one second at the setting mode menu. Measured data can't be displayed in this mode. Operations such as measurements, alarm detection, and data acquisition are continued.	Settings of the functions.

Functions and Operations in the Operation Mode

Operation screen

Display various operation screens such as digital,trend, bar graph,historical trend,alarm summary, print and back up.

Screens are switched by the [Page] key. See section 4.1.

The operation screen with different key operating has the different functions. The concrete pressed key operation and the function please see section 4.1.

Functions of setting modes

Use arrow keys and [En] key to set the instrument's functions.

3.4 Common key operations

This section describes common key operations which are used often.

Key operations in the setting mode

Entering the setting mode

1. Power on immediacy enter the setting mode
2. Select [Exit] to enter the setting mode in the configuration mode.

Switching the screens under the setting mode

Press [Page] to display each setting screen in turn.

Key operations in the configuration mode

Entering the configuration mode

1. Under the setting mode, Press [Page] and [En] to enter the configuration screen.
2. Move the cursor and press the [En] to enter each configuration screen.

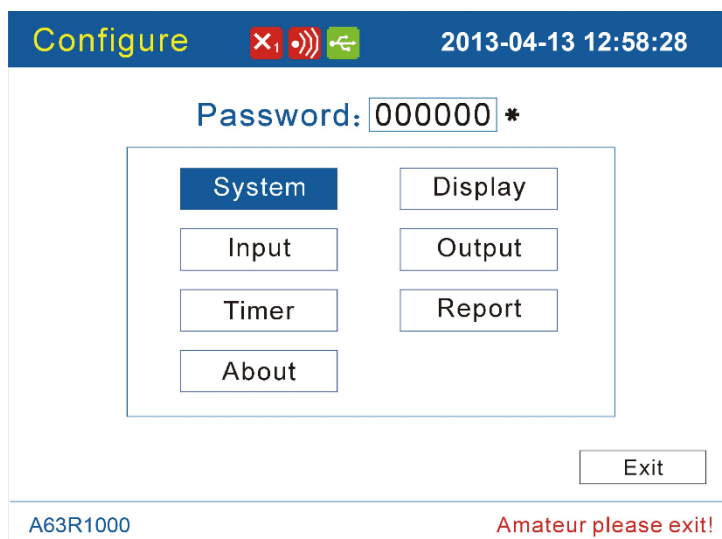

Selecting the parameter

Used [Left] and [Right] to move the cursor (blue) to the appropriate parameter or operation key.

Confirming operation

Press [En] to confirm the settings.

Modifying the parameter

There are two types of the revisable parameters, select input parameter and edit input parameter.

- Selecting input parameter(The right of the input frame has the sign )

Used [Up] and [Down] to move the cursor to modify the appropriate parameter.

- Edit input parameter(The right of the input frame has no sign)

When the parameter can be edited, user can input Number, English (Caps), English, Symbol and Chinese.

Move the cursor to the edited parameter, press [En] to the input panel, user can do it.

Input Number/English (Caps)/English/Symbol

Used in inputting range, unit, tag etc.

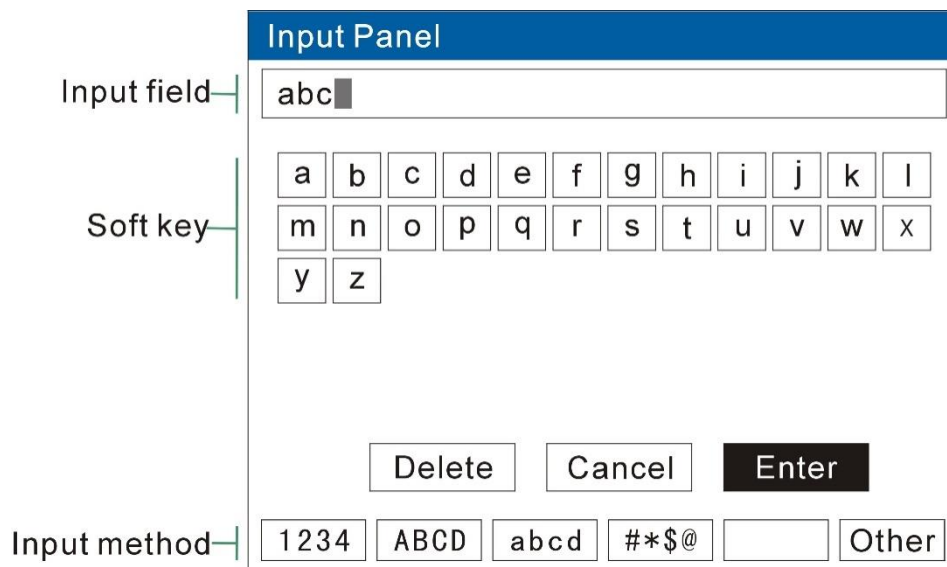

Procedure

- [Left][Right]: Move the cursor to the soft key or input method.
- [Up][Down]: Move the cursor of the soft key.
- [Page]: Switch the cursor's area.(Soft key /Input method)。
- [En]: Input the character to the input field, which under the place of cursor.
 - Cursor at [Delete]: Delete the last character in the input field.
 - Cursor at [Cancel]: Exit the input panel, cancel the editing.
 - Cursor at [Enter]: Exit the input panel, confirm the editing.
 - If the cursor at the input method area, you can switch it to the soft key area.

Chapter 4 Switching Operation Screens

4.1 Switching operation screens

This chapter describes the screen (operation screen) used to display the measured / computed data.

The operation screens are composed of Overview, Bar, Trend, History, Alarm summary, Print (Add-ones function) and Backup (Add-ones function).



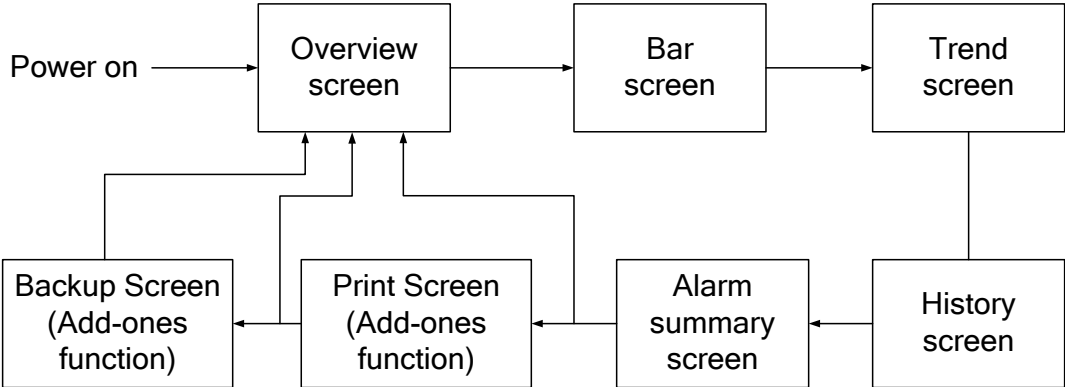



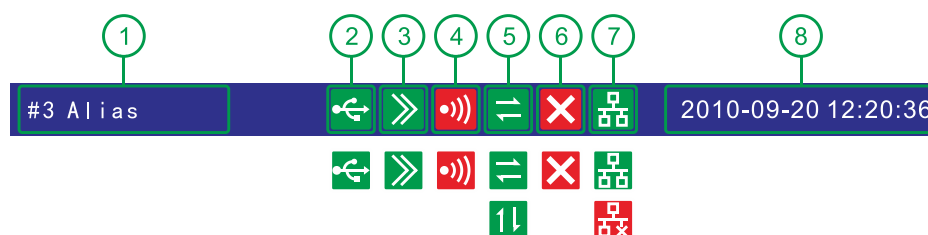

Used the [Page] key can switch each screen.



4.2 Explanation of the status Display Section

The following information is displayed in the status display section during the operation mode and the configuration mode.



NO.	Function	Icon	Description
1	Title bar		It shows combination number or. <i>Device name</i> .
2	USB drive	None	The meter is no connected with a USB drive or it fails to connect with a USB.
			The meter is connected with a USB drive.
3	Loop Playback	None	The screen shows a certain picture. It won't be played in a cycle play mode.
			It will show every display group in loop playback mode.
4	Rely output	None	There isn't any rely output.
			There is rely output.
5	History mode		Continuous state
			Fixed point seek state
6	Abnormal I/O card	None	The I/O card works well.
			The I/O card doesn't work well. (Please contact with the supplier.)
7	Ethernet	None	This product doesn't have Ethernet function.
			Normal connect with Ethernet
			Abnormal connect with Ethernet (disconnect or IP address conflict)
8	Time		The date and time when the meter is operating

4.3 PID screen

Display PID screen. Note: PID screen is shown in the PID function has ordered.

For the display method, see the "Switching operation screen" section.

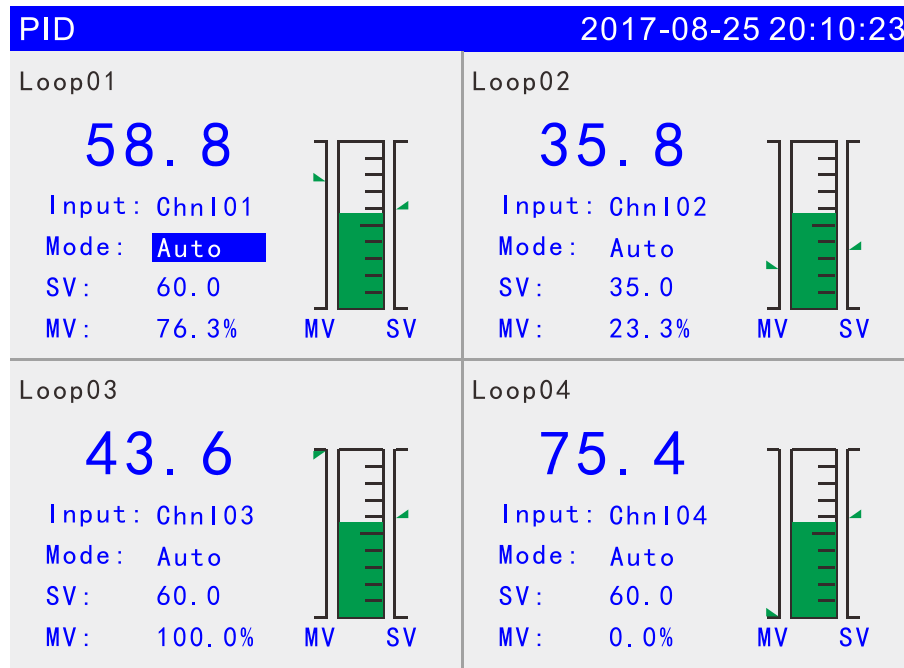

1. PID loop name.
2. Measurement value: shows the measurement value of the loop.
3. Input channel: input channel for measurement value.
4. Control mode: manual or automatic mode switching. Move the cursor to change position and press [Up/Down] to switch.
5. Set value: this value is the target value that the loop needs to set, and press [Up/Down] to modify.
6. Threshold value: this value can be modified by the "man" working mode, and the MV can be modified by the [Up/Down] key. In the "auto" mode, the MV value is output by meter.
7. At the left of the bar, the corresponding point is the set value of the PID loop.
8. On the right of the bar graph, the corresponding point is the valve position value of the PID loop.
9. The color block filled in the middle of the bar chart is the input value of the PID loop.

4.4 Overview screen

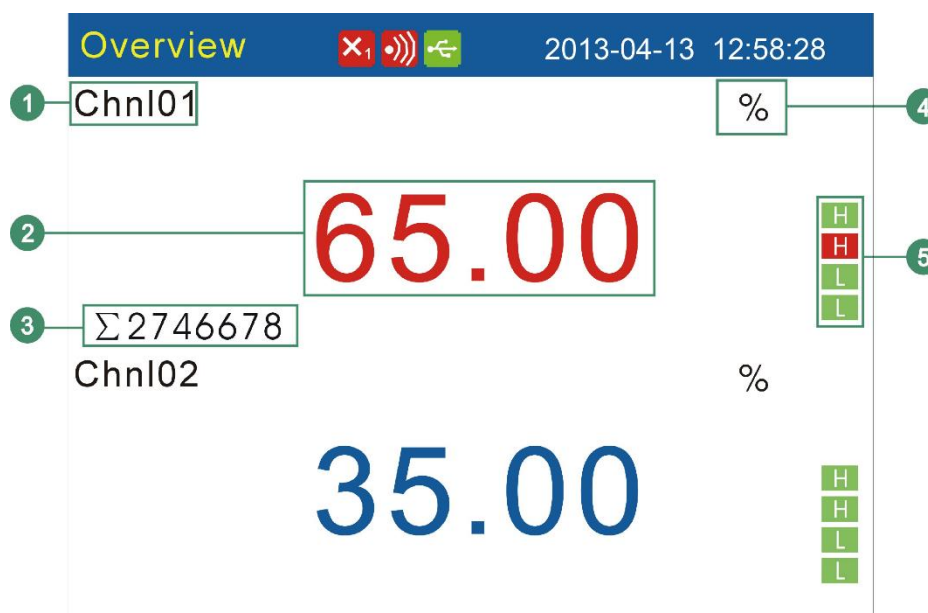

1. Channel tag. See section 『Channel Tag and Unit Setting』
2. Engineering value. Blue is Normal, red is alarming

Note

- Measure the channel's data display
When measuring data of measurement channel anomalies (see below), the screen shows measurements for #####.
 - Data exception
4-20 mA:signal bellows 2 mA.
The thermocouple burnout,the [burnout set] display #####.
-

3. Channel accumulation value.
4. Channel unit. See section 『Channel Tag and Unit Setting』
5. Alarm symbol. From up to down, high-high alarm, high alarm, low alarm, low-lowalarm. Green is normal, red is alarm.

4.5 Bar Graph Display

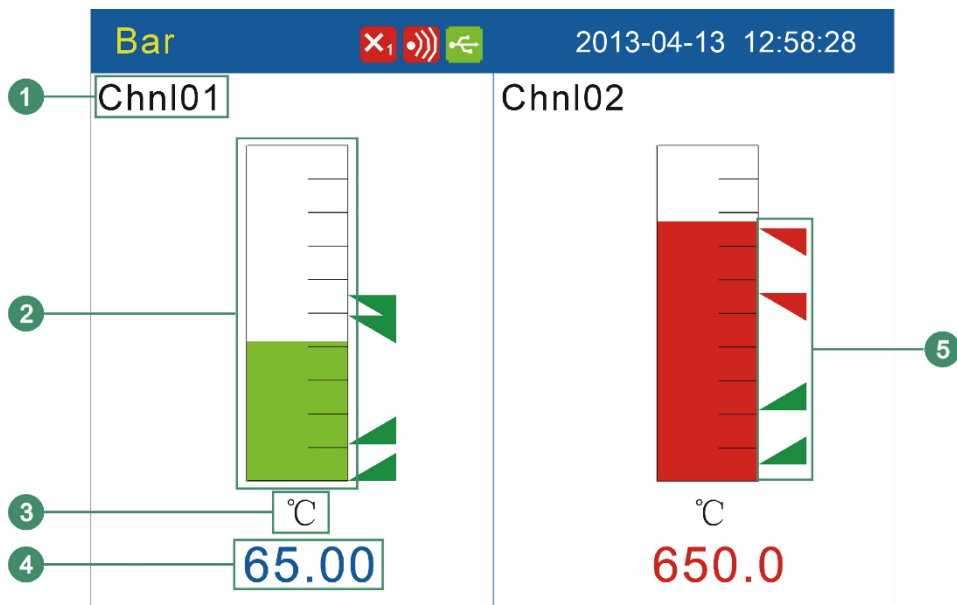

1. Channel tag. See section 『Channel Tag and Unit Setting』
2. Bar. Bar chart ruler has the length of 10 grids, and the length of filling color represents proportion in percent. Green is normal, red is alarm.
3. Channel unit. See section 『Channel Tag and Unit Setting』
4. Engineering value .Blue is normal, red is alarm.

Note

- Measure the channel's data display
When measuring data of measurement channel anomalies (see below), the screen shows measurements for #####.
 - Data exception
4-20 mA: signal bellows 2 mA.
The thermocouple burnout, the [burnout set] display #####.
-

5. Alarm symbol. From up to down, high-high alarm, high alarm, low alarm, low-low alarm. Green is normal, red is alarm. Indications of each channel's alarm state.

4.6 Trend screen

Trend display(Vertical)

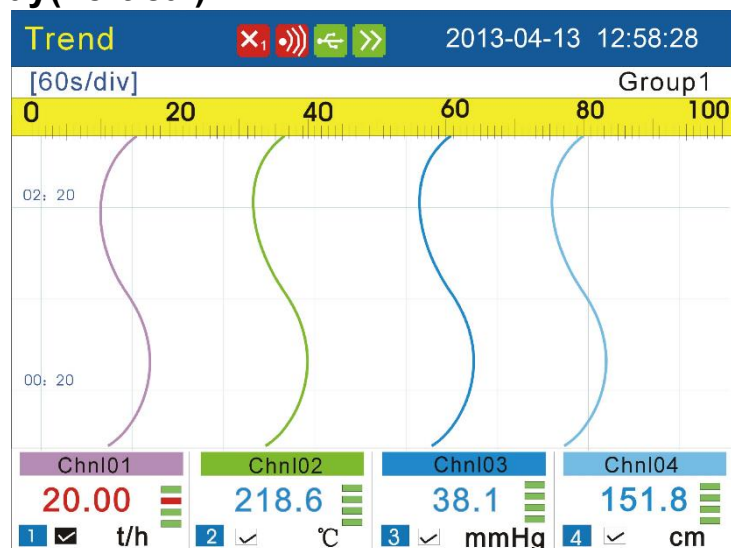

Trend display(Horizontal)

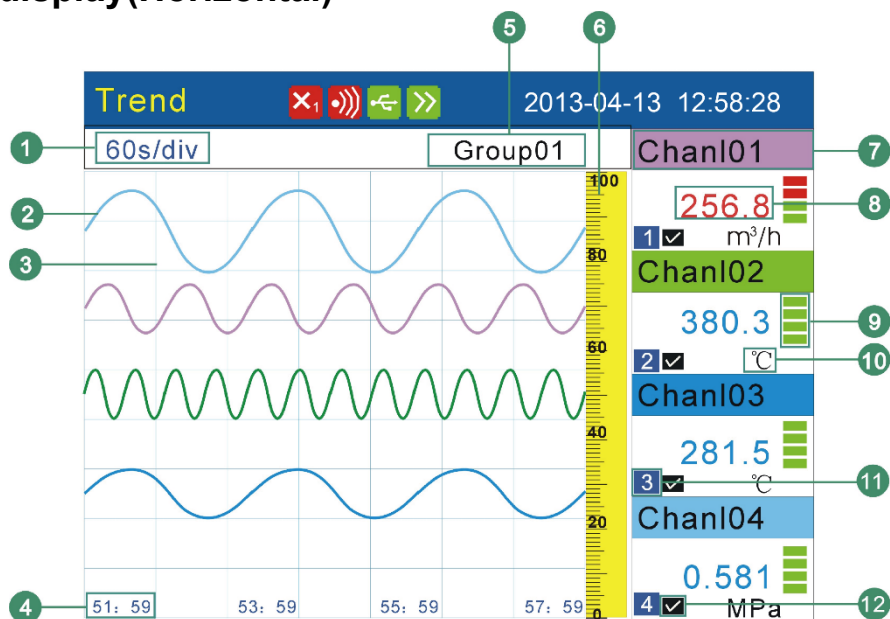

1. Trend cycle. Each grid means the length. The cycle is related with saving interval, each grid time length = saving interval × 30.
2. Data trend. Most display 4 trends at the same screen.
3. Grid. Estimate the time and data value.
4. Time of the current grid.
5. Trendcombination. Display the name of the current combination.
6. Scale. Display the percentage the trend.
7. Channel tag. Background color and this corresponding trendcolorare identical.
8. Engineering value.

Note

- **Measure the channel's data display**
When measuring data of measurement channel anomalies (see below), the screen shows measurements for #####.
 - **Data exception**
4-20 mA: signal bellows 2 mA.
The thermocouple burnout, the [burnout set] display #####.
-

9. Alarm symbol. From up to down, high-high alarm, high alarm, low alarm, low-low alarm. Green is normal, red is alarm. Indications of each channel's alarm state.
10. Channel unit. See the section of 『Channel Tag and Unit Setting』
11. Trend sequence number
12. Trend display symbol. “√” display, “×” hide.

Trends refurbish

On time axis of the instrument's LCD screen, every pixel stands for a record interval. Every record interval in trend moves once.

Group circulation

When started the circulation display function, switched to next group display trend for every 10 seconds.

Procedure**Switch trend display group**

[Up] is used to switch to next effectual group display trend.

Circular display the trend display group

[En] is used to open or close display with circulation. When open this function, there will be an icon appeared in the state bar. See section『Explanation of the status Display Section』.

Display or hide a trend

Move the cursor (black) with [Left] and [Right] keys, pitch on the channel needing display or hide a trend, press [Down] to hide or display the trend.

4.7 History screen

Trend display(Vertical)

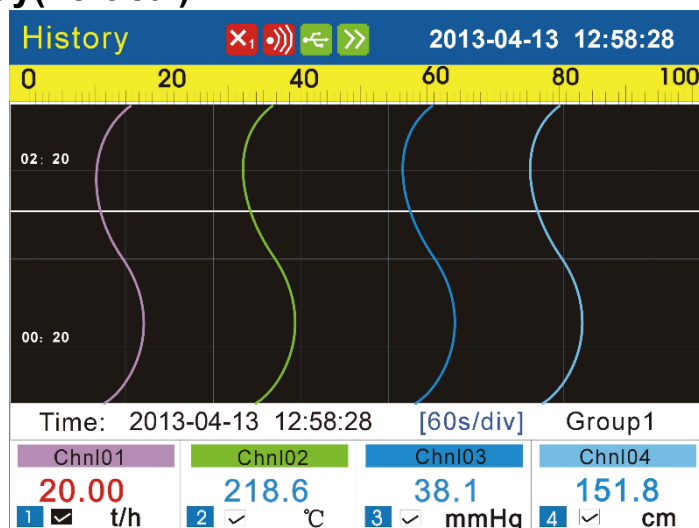

Trend display(Horizontal)

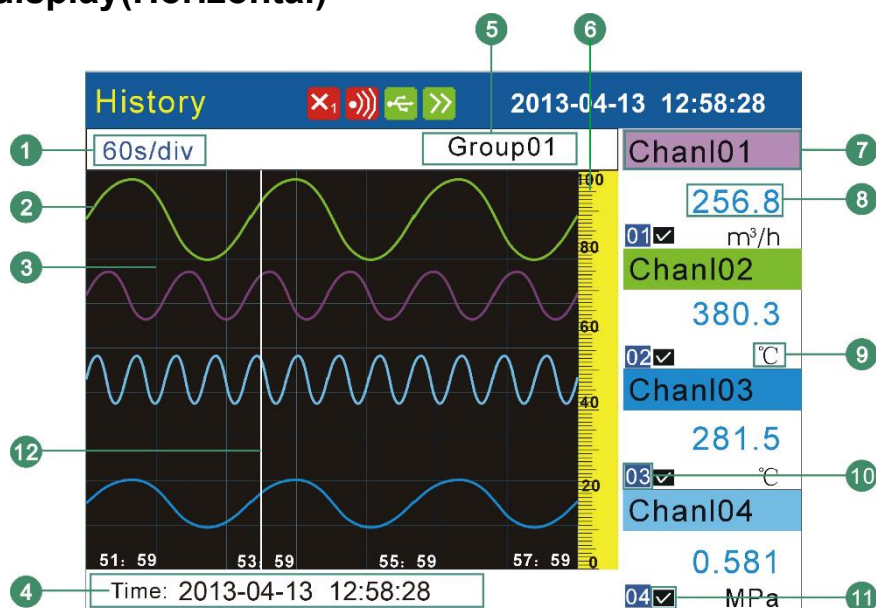

1. Trend cycle. Each grid means the length. The cycle is related with saving interval, Time length = saving interval × Zoom multiple × 30.
2. Data trend. Most display 4 trends at the same screen.
3. Grid. Estimate the time and data value.
4. Cursor time. The time of the trend.
5. Trendcombination. Display the name of the current combination.
6. Scale. Display the percentage the trend.
7. Channel tag. Background color and this corresponding trendcolorare identical.
8. Engineering value.
9. Channel unit. See the section of 『Channel Tag and Unit Setting』
10. Trend sequence number
11. Trend display symbol. “√” display, “×” hide.

Procedure

There exist two methods to search historical data. One is continuous and the other is fixed point.

The current state tag, please see section of 『Explanation of the status Display Section』.

Switch the continuous state and the fixed point state

Under the continuous state, press [En] to switch to the fixed point state.

Under the fixed point state, press [En] to switch to the continuous state.

Continuous state

Switch channel trend

Within this state, uses [up] to display the next channel's trend.

Trend zoom

Under the continuous state, press [Down] to switch the trend zoom times, circulation switch between 1 times/ 2 times/ 4 times/ 8 times/ 16 times/ 32 times.

Operation

Uses [Left] and [Right] to move cursor so that forward or backward searching is available.

The trend moves 1/3 screen trend voluntarily when the trend cursor remove arrives at screen border.

Fixed point state

Display or hide the trend

Within this state, uses [Left] and [Right] to move cursor (Black) and chooses the trend in channel to be displayed or hided by pressing [Down].

Operation

Uses [Left] and [Right] to move cursor. Set the data time to a desired point by using [Up] and [Down]. Press [En], the trend will be moved to the fixed point automatically.

4.8 Alarm summary

Displayed most 15 pieces alarm information, at the same time displayed the state of the relay.

The screenshot shows an 'Alarm Summary' screen with a title bar containing the date and time '2013-04-13 12:58:28'. Below the title bar is a table with columns: 'Chn1', 'Start', 'Stop', and 'Type'. The table contains several rows of alarm data. At the bottom of the screen is a row of 12 relay status indicators labeled '1R' through '12R', each with a colored background (green or red) and a small 'R' suffix. Numbered callouts (1-9) point to specific elements: 1 points to the 'Chn1' column header, 2 to a row in the table, 3 to the 'Start' column header, 4 to the 'Stop' column header, 5 to the 'Type' column header, 6 to a 'Start' time value, 7 to a 'Stop' time value, 8 to a 'Type' value, and 9 to the relay status row.

Chn1	Start	Stop	Type
01	2013-03-15 10: 12: 43	2013-03-15 10: 12: 44	LL
02	2013-03-15 10: 12: 45	2013-03-15 10: 12: 46	L
04	2013-03-15 10: 12: 47	2013-03-15 10: 12: 48	LL
03	2013-03-15 10: 12: 49	2013-03-15 10: 12: 50	L
02	2013-03-15 10: 12: 51	2013-03-15 10: 12: 52	LL

Relay status row: 1R, 2R, 3R, 4R, 5R, 6R, 7R, 8R, 9R, 10R, 11R, 12R

1. Channel tag. Displayed the alarm information.
2. Channel sequence number.
3. Alarm time. Displayed the alarm occur
4. Eliminate alarm time. Displayed the alarm
5. Alarm type. Displayed the alarm type.
6. This alarm time.
7. This eliminates alarm time.
8. This alarm type.
9. Relay state. Displayed 12 pieces of relay output state.

Relay type	Normal open	Normal close
Green	Open	Close
Red	Close	Open

4.9 Report

There are four types of cumulative report (Hourly, 8Hourly, 12Hourly, Daily, Monthly)

Report-Hourly

Report-Hourly			2013-04-13 14:11:26
01: 0.00	09: 0.00	17: 0.00	
02: 0.00	10: 0.00	18: 0.00	
03: 0.00	11: 0.00	19: 0.00	
04: 0.00	12: 0.00	20: 0.00	
05: 0.00	13: 0.00	21: 0.00	
06: 0.00	14: 0.00	22: 0.00	
07: 0.00	15: 0.00	23: 0.00	
08: 0.00	16: 0.00	00: 0.00	
Σ 3.69		Daily Sum : 0.00	
Date: 2013-04-12	Chnl: Chnl01	Print	

1. Query

Query report by setting the date, uses [Left] or [Right] key to move the cursor, Press [Up] or [Down] key to configure the time .The report displays 24 hours' accumulation values on the screen.

2. Channel selection

Move the cursor to the edit box of channel, Press [Up] or [Down] key to select the channel.

3. Print

Move the cursor to the button named "Print", press [En] to print the report of current screen.

Report-8Hourly

Report-8Hourly		2013-04-13 14:11:26	
04-12: 0.00	0.00	0.00	0.00
04-13: 0.00	0.00	0.00	0.00
04-14: 0.00	0.00	0.00	0.00
04-15: 0.00	0.00	0.00	0.00
04-16: 0.00	0.00	0.00	0.00
04-17: 0.00	0.00	0.00	0.00
04-18: 0.00	0.00	0.00	0.00
04-19: 0.00	0.00	0.00	0.00
Σ 3.69			
Date:	2013-04-12	Chnl:	Chnl01
	<input type="button" value="Print"/>		

1. Query

Query report by setting the date, uses [Left] or [Right] key to move the cursor, Press [Up] or [Down] key to configure the time. Display the data of 7 days since the date of the settlement, 3 cumulative values for each day.

2. Channel selection

Move the cursor to the edit box of channel, Press [Up] or [Down] key to select the channel.

3. Print

Move the cursor to the button named "Print", press [En] to print the report of current screen.

Report-12Hourly

Report-12Hourly	2013-04-13 14:11:26
04-12: 0.00	0.00
04-13: 0.00	0.00
04-14: 0.00	0.00
04-15: 0.00	0.00
04-16: 0.00	0.00
04-17: 0.00	0.00
04-18: 0.00	0.00
04-19: 0.00	0.00
Σ 3.69	
Date: 2013-04-12	Chnl: Chnl01
Print	

1. Query

Query report by setting the date, uses [Left] or [Right] key to move the cursor, Press [Up] or [Down] key to configure the time. Display the data of 7 days since the date of the settlement, 2 cumulative values for each day.

2. Channel selection

Move the cursor to the edit box of channel, Press [Up] or [Down] key to select the channel.

3. Print

Move the cursor to the button named "Print", press [En] to print the report of current screen.

Report-Daily

Report-Daily		2013-04-13 14:11:26
01: 0.00	12: 0.00	23: 0.00
02: 0.00	13: 0.00	24: 0.00
03: 0.00	14: 0.00	25: 0.00
04: 0.00	15: 0.00	26: 0.00
05: 0.00	16: 0.00	27: 0.00
06: 0.00	17: 0.00	28: 0.00
07: 0.00	18: 0.00	29: 0.00
08: 0.00	19: 0.00	30: 0.00
09: 0.00	20: 0.00	31: 0.00
10: 0.00	21: 0.00	
11: 0.00	22: 0.00	Σ 3.69
Date: 2013-03	Chnl: Chnl01	Mon Sum: 0.00
<input type="button" value="Print"/>	<input type="button" value="Monthly"/>	Average: 0.00
		Maximum: 0.00
		Minimum: 0.00

1. Query

Query report by setting the date, uses [Left] or [Right] key to move the cursor, Press [Up] or [Down] key to configure the time. Display the data of 7 days since the date of the settlement, 2 cumulative values for each day.

2. Channel selection

Move the cursor to the edit box of channel, Press [Up] or [Down] key to select the channel.

3. Print

Move the cursor to the button named "Print", press [En] to print the report of current screen.

4. Report –Monthly

Move the cursor to the button named "Monthly", press [En] to display monthly report.

5. Stat.

Display the value of month sum, average, maximum and minimum

Report-Monthly

Report-Monthly		2013-04-13 14:11:26	
2012-04: 0.00		2012-11: 0.00	
2012-05: 0.00		2012-12: 0.00	
2012-06: 0.00		2013-01: 0.00	
2012-07: 0.00		2013-02: 0.00	
2012-08: 0.00		2013-03: 0.00	
2012-09: 0.00		2013-04: 0.00	
2012-10: 0.00			
Annual Sum: 0.00			
Σ 3.69			
		Print	Exit

1. Display cumulative value of 13 months before current month
2. Move the cursor to the [Print] key, press the [En] key to print the current screen.
3. Move the cursor to the [Exit] key, press the [En] key back to the screen of Report-Daily.

Chapter 5 System Configurations

5.1 Setting Alias\Date\Language>Password\RJC

Procedure

[Configuration menu] -> [System]

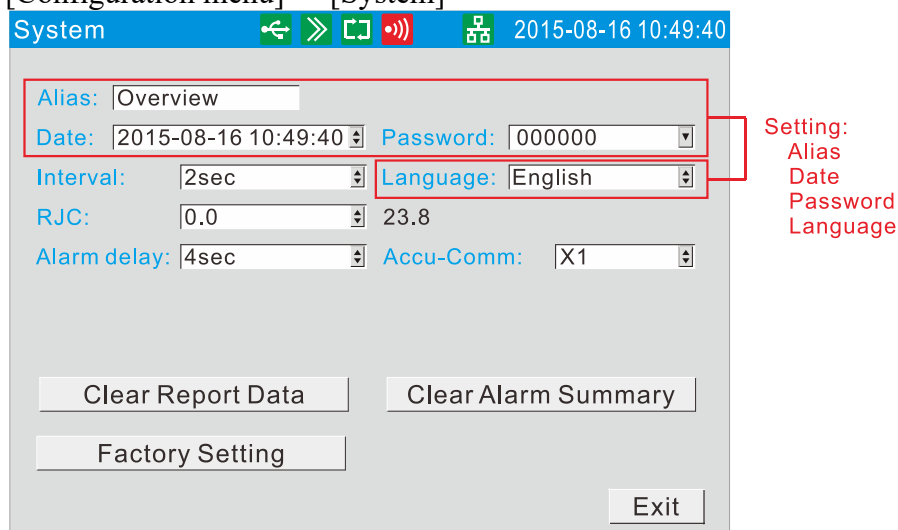

Parameter

1. Alias name; display it on the title bar. Use that name to create the directory of data backup and automatic backup.

2. System Time: This field is to set meter's current date and time.

Caution

After setting system date / time, those historical data stored in instrument is invalid.

New and effective data begins after setting system date / time.

Before setting system date / time, please backup history data.

3. Display language (Chinese and English).
4. System password is used to modify Configuration parameters and prevent the system parameters from being accidentally modified. System password is six digits.

Note

It is a unique password to modify configuration parameters. Once it is forgotten, it cannot be modified those parameters.

The initial password is 000000, after purchasing instrument, it is better for users to amend it as soon as possible and preserve it properly.

5.2 Setting Trend Direction and Groups of the Trend

User can choose two directions of trends, horizontal and vertical. When the horizontal, the trend is from right to left; when vertical, it's from up to down.

User can set four trend groups and enable it to use. Each trend is composed of 1-4 trends, has 4 kind of different trend colors.

Procedure

Press [Page] and [En] at the same time, enter the configuration menu.

Use arrow keys and [En] to input the password, enter the [Display] screen.

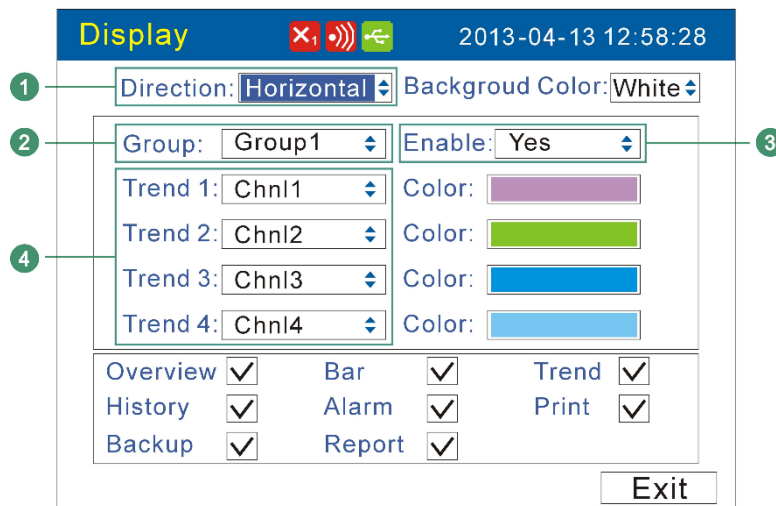

1. Set the trend direction

Press arrow keys to choose the trend direction, horizontal or vertical. It's usable for Trend and History.

2. Select the trend group

Press arrow keys to choose trend group.

3. Enable the trend group to use or no

Move the cursor to [Enable], and use the arrow keys to set the trend group.

4. Set the channel of current trend

User can input channels at discretion, there are four colors for the trend in right side.

Confirming operation

After the parameter setting, select [Exit] there is a Frame.

Select [Yes] to save setting content, and exit [Display] screen.

Select [No] to cancel setting content, and exit [Display] screen.

Select [Cancel] to continue setting parameters in [Display] screen.

5.3 Show/Hide the Run Screens

Procedure

Press [Page] and [En] at the same time, enter the configuration menu.

Use arrow keys and [En] to input the password, enter the [Display] screen.

The screenshot shows the 'Display' configuration interface. At the top, the title 'Display' is in yellow on a blue background, followed by system icons and the timestamp '2013-04-13 12:58:28'. Below the title bar, the 'Direction' is set to 'Horizontal' and 'Background Color' is 'White'. A central panel contains four trend settings: 'Trend 1' (Chnl1, purple), 'Trend 2' (Chnl2, green), 'Trend 3' (Chnl3, blue), and 'Trend 4' (Chnl4, light blue). Below this panel is a table of checkboxes for various features: Overview, History, Backup, Bar, Alarm, Report, Trend, and Print, all of which are checked. An 'Exit' button is located at the bottom right of the screen.

Show or Hide the Run Screens

Press arrow keys to show or hide the relevant screens.

Confirming operation

After the parameter setting, select [Exit] there is a Frame.

Select [Yes] to save setting content, and exit [Display] screen.

Select [No] to cancel setting content, and exit [Display] screen.

Select [Cancel] to continue setting parameters in [Display] screen.

5.4 Setting Background Color

User can choose background color for the screen of overview and bar.

Procedure

Press [Page] and [En] at the same time, enter the configuration menu.

Use arrow keys and [En] to input the password, enter the [Display] screen.

Display		2013-04-13 13:21:32	
Direction:	Horizontal	Background Color:	White
Group:	Group1	Enable:	Yes
Trend 1:	Chnl1	Color:	[Magenta]
Trend 2:	Chnl2	Color:	[Green]
Trend 3:	Chnl3	Color:	[Blue]
Trend 4:	Chnl4	Color:	[Cyan]
Overview	<input checked="" type="checkbox"/>	Bar	<input checked="" type="checkbox"/>
History	<input checked="" type="checkbox"/>	Alarm	<input checked="" type="checkbox"/>
Backup	<input checked="" type="checkbox"/>	Trend	<input checked="" type="checkbox"/>
		Print	<input checked="" type="checkbox"/>
			Exit

Setting Background Color

Press arrow keys to choose white or black color for the background of overview and bar screens

Confirming operation

After the parameter setting, select [Exit] there is a Frame.

Select [Yes] to save setting content, and exit [Display] screen.

Select [No] to cancel setting content, and exit [Display] screen.

Select [Cancel] to continue setting parameters in [Display] screen.

Chapter 6 Input Channel Settings

6.1 Input Parameter Setting

Procedure

[Configuration menu] -> [Input]

Input 2015-08-16 10:49:40

Channel:	1	Tag:	Chnl01		
Type:	Sin	Unit:	t/h		
Range:	4.00	20.00	Filter:	0.0s	
Vacuum:	No	Cut:	0.0%	Sqrt:	No
Burnout Set:	Minimize	Frequency:	1		
Accumulate:	No	Acc.Magnification:	1		

	LL	L	H	HH	Zone
Value	5.00	6.00	18.00	19.00	1
Relay	1	2	3	4	

K=: 1.00 B=: 0.00 Clear Acc Copy01 Exit

Setting:
Channel
Tag
Type
Unit
Range
Filter
Vacuum
Cut
Sqrt
Burnout
Frequency
K+B

Parameter

1. **Channel:** Select the channel to set the parameter, which is limited of the input board channel's number.
2. **Tag:** Input channel tag, most ten English characters.
3. **Type:** Set the current channel's input signal type.
4. **Unit:** Input channel unit, most seven English characters.
5. **Range:** Set the current channel's input signal measuring range. The high and low value should not be the same. The low value is -9999 and high range is 19999.
6. **Filter:** the range from 0.0S to 9.9S.

Note

$$\text{Show value} = \frac{\text{Last value} \times \text{Input filter} + \text{Current value}}{\text{Input filter} + 1}$$

7. **Vacuum:** There are two vacuum types, normal arithmetic and subsection arithmetic. User can choose it base on vacuum transmitter signal.

- Linear operation

Semaphore transforms to project quantity according to the signal range and practical range of linear

- Ordinary vacuum operation

Semaphores and vacuum degree of logarithm has a linear relationship, signal range in the overall signal is free to set, and the project range is expressed by 10 of the index form, ranging from $10E-9.999$ to $10E9.999$.

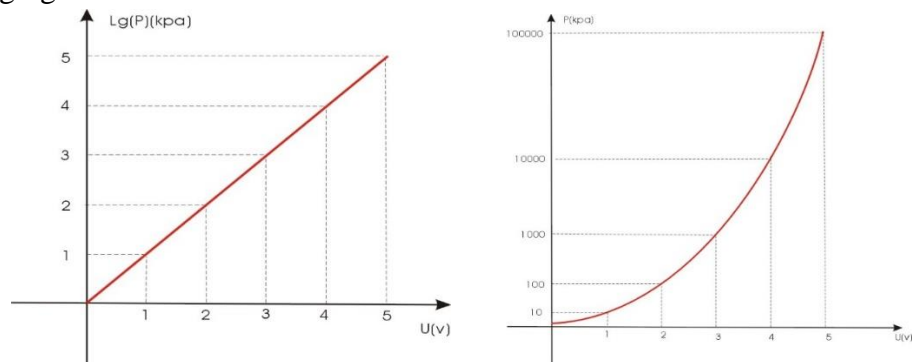

- Sub-vacuum operation

According to the vacuum degree of order , divide it into a number of sections , the corresponding signal of endpoint in every section and the vacuum degree has a linear relationship, at the same time, corresponding signal in the same section and the vacuum have a linear relationship too. Signal range in the overall signal is free to set; the project range is expressed by 10 of the index form, ranging from $10E-9.999$ to $10E9.999$.

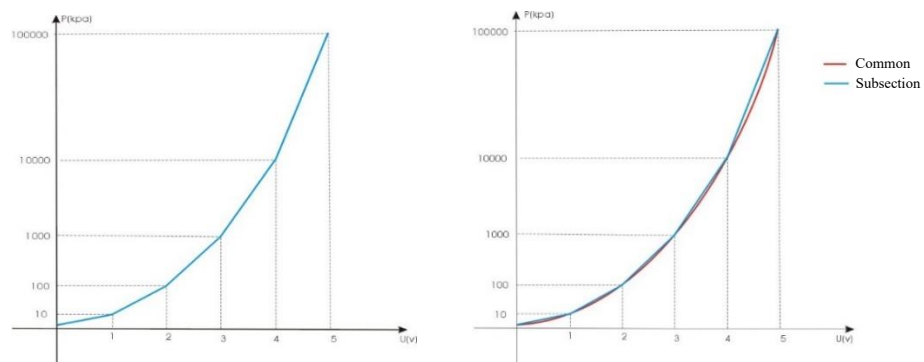

Eg1.

Linear vacuum sensor: signal output limit is 0 ~ 5V, and measuring limit is E-3(lower) ~ E+5(upper), vacuum degree unit is Pa, linear conversion of vacuum degree into voltage signal.

Let $P=10^{ku+b}$, P is vacuum degree, u is voltage, and substitute the upper and lower limits of signal and range to calculate $P=10^{1.6u-3}$.

Instrument setting: signal input type is voltage 0-10V, vacuum is [Common], and measuring limit is E-3(lower) ~ E+5(upper).

Calculation: When the input voltage signal is 4V, linear conversion of voltage signal to vacuum degree, $P=10^{1.6 \times 4 - 3} = 2.5E+3$.

Eg2.

Segment vacuum sensor: signal output limit is 0 ~ 10V, and measuring limit is E+5(lower) ~ E-1(upper), vacuum degree unit is Pa. The corresponding signal values of sectional vacuum are as follows.

真空度范围	0~10V 电压
E5~E4	0.00~1.67
E4~E3	1.67~3.34
E3~E2	3.34~5.01
E2~E1	5.01~6.68
E1~E0	6.68~8.35
E0~E-1	8.35~10.00

Instrument setting: signal input type is voltage 0-10V, vacuum is [Subsection], and measuring limit is E+5 (lower) ~ E-1(upper).

Calculation: When the input voltage signal is 2V, $P=1.9 \times 10^4 - 2 \times 5.4 \times 10^3 = 8.2E+3$.

8. **Small signal cutting:** If the signal is smaller than the signal cutting percent, it will be forced into lower limit of measurement range.

Note

That the small signal cutting is to point to when rate of flow is lower than some threshold value, regard it being irrespective of flow turn to be able to ignore, flow shows for zero.

9. **Square root computation:** Square root calculation for flow calculation.

Note

Need to use to square root function in measurement differential pressure flow meter in pore plate, a few flow meter not bringing the square root function along per se, can use this function.

10. **Burnout Set:** Value when the signal line breaks display and storage.

Setting	Result
Minimize	Low limit
Max	High limit
Hold front value	Fix the finally right value before burnout
Error flag	#####

11. **Adjust value:** Set the correct value, Display data=Measure data \times K+B.

Measuring range

Type	Range	Measuring range
Current	4-20mA	4.00mA ~ 20.00mA
	0-10mA	0.00mA ~ 10.00mA
Volt	1-5V	1.000V ~ 5.000V
	0-5V	0.000V ~ 5.000V
	0-10V	0.000V ~ 10.000V
	20mV	0.00mV ~ 20.00mV
	100mV	0.00mV ~ 100.00mV
Resistance	350 Ω	0.0 Ω ~ 350.0 Ω
Frequency	FR	0Hz ~ 10000Hz
RTD	PT100	-200.0 $^{\circ}$ C ~ 650.0 $^{\circ}$ C
	Cu50	-50.0 $^{\circ}$ C ~ 140.0 $^{\circ}$ C
	Cu53	-50.0 $^{\circ}$ C ~ 150.0 $^{\circ}$ C
	BA1	-100 $^{\circ}$ C ~ 600 $^{\circ}$ C
	BA2	-100 $^{\circ}$ C ~ 600 $^{\circ}$ C
TC	S	-100 $^{\circ}$ C ~ 1600 $^{\circ}$ C
	R	-50 $^{\circ}$ C ~ 1600 $^{\circ}$ C
	B	500 $^{\circ}$ C ~ 1800 $^{\circ}$ C
	K	-50 $^{\circ}$ C ~ 1300 $^{\circ}$ C
	N	-200 $^{\circ}$ C ~ 1300 $^{\circ}$ C
	E	-100 $^{\circ}$ C ~ 1000 $^{\circ}$ C
	J	-100 $^{\circ}$ C ~ 1000 $^{\circ}$ C
	T	-100 $^{\circ}$ C ~ 380 $^{\circ}$ C
	WRE5-26	0 $^{\circ}$ C ~ 2310 $^{\circ}$ C
	WRE3-25	0 $^{\circ}$ C ~ 2315 $^{\circ}$ C
	F1	600 $^{\circ}$ C ~ 2000 $^{\circ}$ C
	F2	600 $^{\circ}$ C ~ 2000 $^{\circ}$ C
simulation	sin	Set the range freely.

6.2 Reference Junction Compensation

Procedure

[Configuration menu] -> [System]

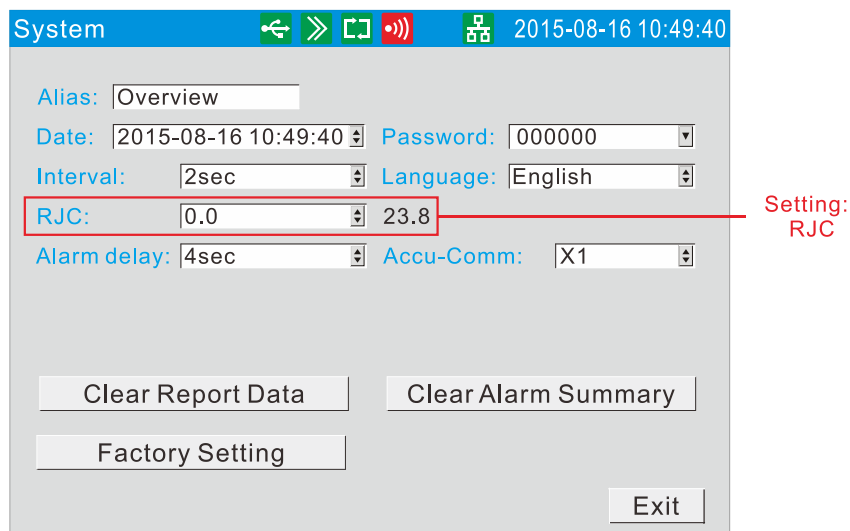

The screenshot shows the 'System' configuration menu. The title bar reads 'System' and the date/time is '2015-08-16 10:49:40'. The settings are as follows:

Alias:	Overview		
Date:	2015-08-16 10:49:40	Password:	000000
Interval:	2sec	Language:	English
RJC:	0.0	23.8	
Alarm delay:	4sec	Accu-Comm:	X1

Buttons at the bottom: Clear Report Data, Clear Alarm Summary, Factory Setting, and Exit.

A red box highlights the RJC setting, and a red line points to the text 'Setting: RJC' on the right.

Parameter

1. CJ compensational value

When there are some differences between the scene temperature and the cold temperature instrument measured, user can use the adjust function.

Compensation value = CJ measurement value + CJ adjusted value

6.3 Accumulation Setting

Procedure

[Configuration menu] -> [Input]

The screenshot shows the 'Input' configuration window with the following settings:

- Channel: 1
- Type: Sin
- Range: 4.00 to 20.00
- Vacuum: No
- Burnout Set: Minimize
- Accumulate: No (highlighted)
- Tag: ChnI01
- Unit: t/h
- Filter: 0.0s
- Cut: 0.0%
- Sqrt: No
- Frequency: 1
- Acc.Magnification: 1 (highlighted)

Below the main settings is a table for relay settings:

	LL	L	H	HH	Zone
Value	5.00	6.00	18.00	19.00	1
Relay	1	2	3	4	

At the bottom, there are fields for K= (1.00) and B= (0.00), and buttons for Clear Acc, Copy01, and Exit.

Parameter

1. **Accumulate:** Enable accumulates function.
2. **Acc.Magnification:** Cumulative value multiplied by a cumulative accumulation rate in accordance with the actual value.

Explanation

Accumulation function is that carries out time integral for current channel measurement value and arithmetic value.

The range of accumulation value is 0 ~ 9,999,999,999.9, one radix point.

It will clear voluntarily when accumulate value exceeding 9,999,999,999.9.

When enabled the accumulation function, the accumulation value can be displayed in the overview screen automatically.

6.4 Copying Channel Parameters

Use this function when channel A and channel B need to set the same parameter.

Procedure

[Configuration menu] -> [Input]

The screenshot shows the 'Input' configuration menu with the following parameters:

- Channel: 1
- Type: Sin
- Range: 4.00 | 20.00
- Vacuum: No
- Burnout Set: Minimize
- Accumulate: No
- Tag: Chnl01
- Unit: t/h
- Filter: 0.0s
- Cut: 0.0%
- Sqrt: No
- Frequency: 1
- Acc.Magnification: 1

Below the parameters is a table for alarm settings:

	LL	L	H	HH	Zone
Value	5.00	6.00	18.00	19.00	1
Relay	1	2	3	4	

At the bottom of the menu, there are buttons for 'K=: 1.00', 'B=: 0.00', 'Clear Acc', 'Copy01', and 'Exit'. The 'Copy01' button is highlighted with a red box, and a red arrow points to it with the label 'Copy Channel'.

Operation

Copy the channel parameter

Move the cursor to [Copy01].

When used the [Up] and [Down] to copy source channel, it may display on the soft key.

Press [En] to confirm copying parameters.

Explanation

The operations can copied the following parameter

Type / Unit / Range / Square / Vacuum / Filter / Cut / low-low Alarm / low Alarm / high Alarm / high-high Alarm / Zone / four touch points / Adjust value.

Chapter 7 Virtual Channel Settings(Optional)

7.1 Virtual Channel Parameter Setting

Procedure

[Configuration menu] -> [Virtual]

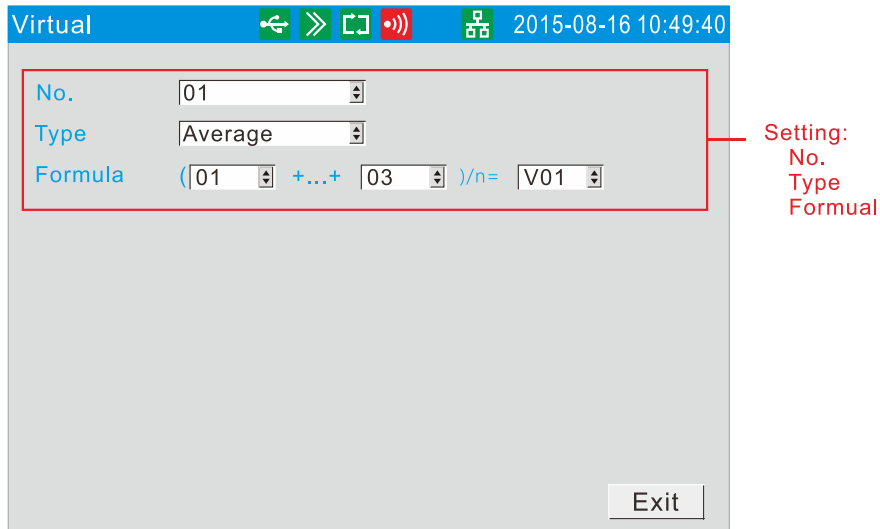

Parameter

1. **No:** The number of virtual computing formula. Most four calculations.
2. **Type:** The type of virtual calculates.
3. **Formula:** The formula of virtual operation. The input channel for the digital, said the virtual channel begin with “V”.

Chapter 8 Setting Alarms

8.1 Alarm Setting

Each channel can set four alarm values, high-high alarm, high alarm, low alarm and low-low alarm.

CAUTION

Set the measurement range before setting the alarm.

All of the alarm settings of a channel are canceled in the following cases:

- When the signal type is changed(Volt, Resistance)
- When the input range is changed
- When the setting compensation or square root operation

Procedure

[Configuration menu] -> [Input]

The screenshot shows the 'Input' configuration screen with the following settings:

- Channel: 1
- Type: Sin
- Range: 4.00 | 20.00
- Vacuum: No
- Burnout Set: Minimize
- Accumulate: No
- Tag: ChnI01
- Unit: t/h
- Filter: 0.0s
- Cut: 0.0%
- Sqrt: No
- Frequency: 1
- Acc.Magnification: 1

The alarm settings table is highlighted with a red box:

	LL	L	H	HH	Zone
Value	5.00	6.00	18.00	19.00	1
Relay	1	2	3	4	

Setting: Alarm

At the bottom of the screen, there are buttons for 'K=: 1.00', 'B=: 0.00', 'Clear Acc', 'Copy01', and 'Exit'.

Parameter

1. **Select the alarm channel**
The setting method is the same as the signal type and signal range
2. **Set the alarm threshold value**
The threshold value must in the channel range.
3. **Set the alarm threshold value zone**
Prevent the relay frequently action when the signal surged by the alarm threshold value.
4. **Set relay number**
Output the relay with setting serial number when an alarm occurs.

Explanation

Alarm condition and Undo Alarm condition

Threshold type	Alarm condition	Undo Alarm condition
high-high threshold	Channel value > high-high threshold	Channel value < high-high threshold-zone.
high threshold	Channel value > high threshold	Channel value < high threshold-zone.
low threshold	Channel value < low threshold	Channel value > low threshold + zone.
low-low threshold	Channel value < low-low threshold	Channel value > low-low threshold + zone.

Relay number setting

Alarm does not output to relay when the relay number setting is zero.

When sharing an alarm output relay among multiple alarms, each alarm will act the relay activated.

Normally closed relay (Option)

The Initialization is normally opened relay, if you need normally closed relay, please contact us.

8.2 Setting the Relay Delay Period

Procedure

[Configuration menu] -> [System]

The screenshot shows the 'System' configuration menu. The 'Alarm delay' field is highlighted with a red box, and a red arrow points to it from the text 'Setting: Relay Delay' on the right. The menu includes the following fields and buttons:

Alias:	Overview
Date:	2015-08-16 10:49:40
Interval:	2sec
RJC:	0.0
Alarm delay:	4sec
Password:	000000
Language:	English
Accu-Comm:	X1

Buttons: Clear Report Data, Clear Alarm Summary, Factory Setting, Exit

Setting: Relay Delay

Parameter

1. The Relay Delay Period

For preventing the relay mistake action, in appearance system group state, relay time lapse can set 0-10 seconds to delay trigger under the system configuration.

Think that the queen who gives an alarm coming into being continues setting up second of inner signal being in the state giving an alarm without exception or continues setting up second of inner signal without exception in eliminating newspaper state, relay only meeting action.

The relay will action when the continue setting second signal under alarm state or undo alarm state.

Chapter 9 Setting Analog Outputs(Optional)

9.1 Analog Outputs Setting

The instrument provides 4-20mA analog output.

Procedure

Press [Page] and [En] at the same time, enter the configuration menu.

Use arrow keys and [En] to input the password, enter the [Output] screen.

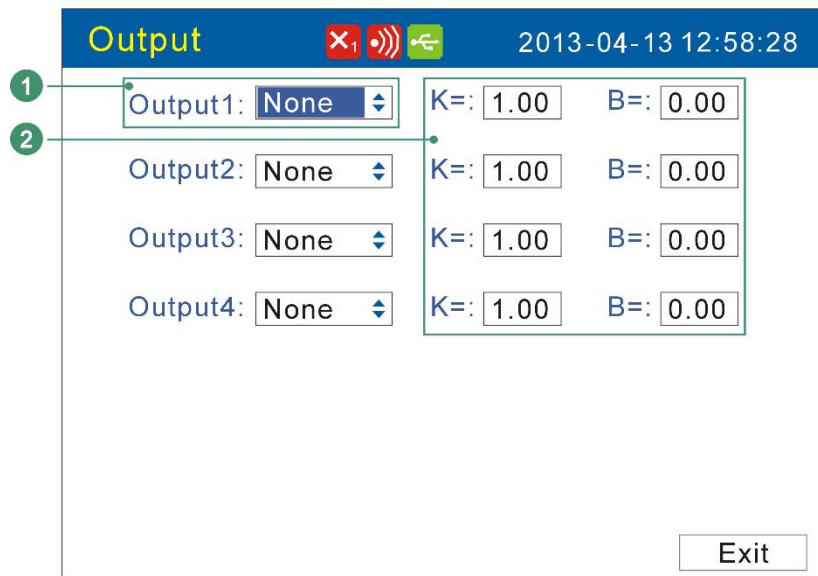

1. **Set the output source channel**
Set the source of this channel output value.
2. **Output the adjust value**
Output value = Current value \times K + B.

Confirming operation

After the parameter setting, select [Exit] there is a Frame.

Select [Yes] to save setting content, and exit [Output] screen.

Select [No] to cancel setting content, and exit [Output] screen.

Select [Cancel] to continue setting parameters in [Output] screen.

Explanation

The analog output only supports 4-20mA

According to the channel measurement range, converts the source channel value to percentage, then transforms to 4-20mA analog output.

When there is no output source channel, the analog output will fix to 4mA.

Chapter 10 Data Saving and Saving to External Medium

10.1 Setting the Saving Interval of Internal Memory

Procedure

Press [Page] and [En] at the same time, enter the configuration menu.

Use arrow keys and [En] to input the password, enter the [System] screen.

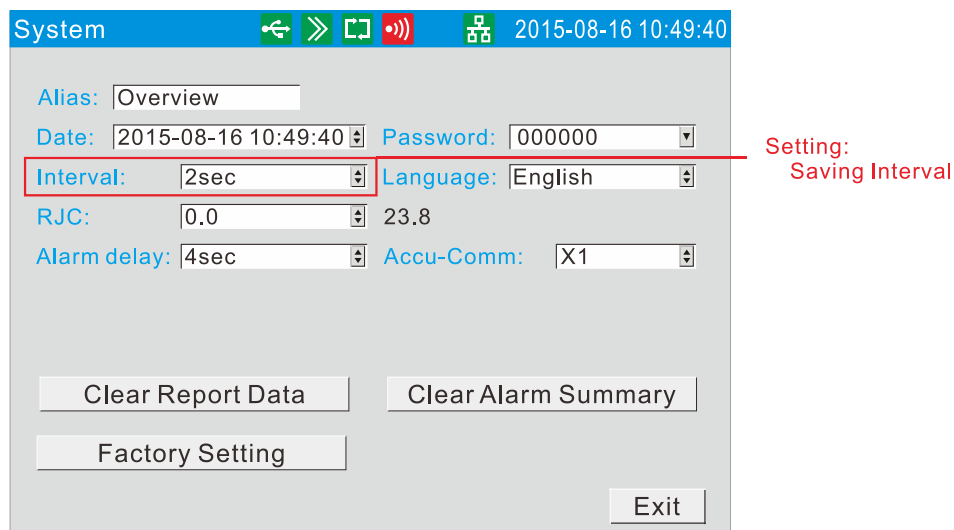

Parameter

1. **Saving interval:** User can choose 1s/2s/5s/10s/15s/30s/1min/2min/4min.

Note

The sample period is 1 second, so the smallest records interval is 1 second.

Increasing the interval can prolong the time length of storage data.

The interior saving historical data will be invalidation if you modify the saving interval, therefore, please backup the historical data before you modify it, prevents the loss.

The relation of the saving interval and time length

Interval	Time length
1 second	72 hour/channel
2 seconds	6 day/ channel
5 seconds	15 day/ channel
10 seconds	30 day/ channel
15 seconds	45 day/ channel
30 seconds	90 day/ channel
1 minutes	180 day/ channel
2 minutes	360 day/ channel
4 minutes	720 day/ channel

10.2 Saving data and format USB(Optional)

Procedure

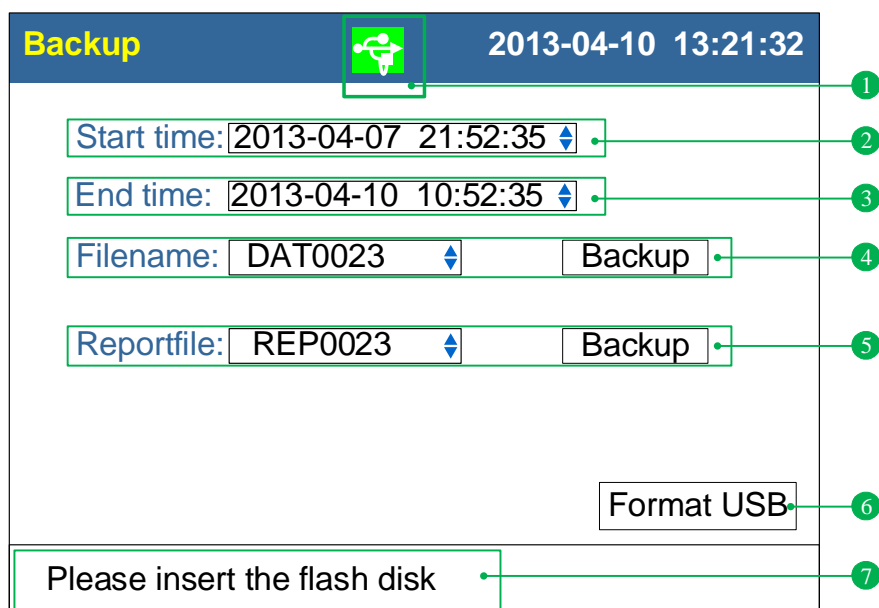

1. U Disk insertion symbol.
2. The internal data starting time.
3. The internal data ending time.
4. Set the data filename, and backup this file.
5. Set the Report file, and backup this file.
6. Quickly format the U Disk flash disk to FAT32 format. Note that formatting will clear the original data in the U Disk.
7. The status bar generally displays prompt information, and the backup progress bar is displayed during backup

Chapter 11 Setting Compensation Parameters(Optional)

11.1 Set Compensation Model and Channel Parameters

This section describes how to set the parameters of temperature and pressure compensation model, flow channel, measuring devices and measuring dielectric, etc.

Operation

Press the [page] and [En], enter the configuration menu.

Use the [arrow keys] and [En] button, enter the password, and then select to enter the [compensation].

Compensation		2013-04-13 12:58:28
Compensation:	Compensation1	◆
Flow Channel:	Chnl01	◆
Measure Device:	Orifice	◆
Measure Media:	Steam	◆
Accumulate Rate:	1	
Little Flow Fill:	0% ◆	0% ◆
Over Scale Set:	100%	◆
Power-off Fill:	0%	◆
Local Atm Pressure:	0.1013MPa	
<input type="button" value="Configure"/> <input type="button" value="Exit"/>		

1. Compensation

Select the compensation channel, a total number of four channels. Select with [Up and Down] key.

2. Flow channel

Set the compensation flow channel. Select with [Up and Down] key.

3. Measuring device

Set the compensation medium measurement device, which has a plate, vortex (frequency), vortex (mA). Select with [Up and Down] key.

4. Measuring medium

Set the measurement medium, which has steam, water and general gases. Select with [Up and Down] key.

5. Cumulative rate

Set accumulation rate values, according to [the instantaneous value × magnification]. Press [En] key to modify the settings, [up and down] key to adjust.

6. Small flow fill

The first setting value is the percentage of small flow limit; the second setting value is the percentage of compensation. The Percentage is all flow range percentage. To adjust settings with [Up and Down] keys.

When the instantaneous flow rate is less than the first set value, the flow accumulation value according to make up the second set.

7. Over-range setting

When instantaneous flow exceeds maximum range, and then it will lead to top destruction, according to [flow range × set value] accumulation. To adjust settings with [Up and Down] keys

8. Power-down fill

Cumulative value and the statements during a power outage is according to [flow range × set value] calculated compensation. To adjust settings with [Up and Down] keys.

9. Parameter setting

Press [En] key to enter the temperature and pressure compensation parameter-setting screen.

Confirming operation

After the parameter setting, select [Exit] there is a Frame.

Select [Yes] to save setting content, and exit [compensation] screen.

Select [No] to cancel setting content, and exit [compensation] screen.

Select [Cancel] to continue setting parameters in [compensation] screen.

Explain

During flow accumulation, it should the first cut the small signal, and then calculated the flow after compensation according to temperature and pressure compensation formula. Then have calculation on small flow compensation, over range compensation, accumulation, and finally get the last flow to accumulate.

11.2 Set Compensation Model Parameters

Orifice + Steam Parameter Setting

This section describes measuring device (orifice) and measuring medium (steam) parameters setting.

Operation

Press the [page] + [En], enter the configuration menu.

Use the [arrow keys] and [En] button, enter the password, and then select to enter the [flow compensation].

Move the cursor to the [Parameter setting] button, press the [En] key to enter the parameter-setting screen.

Configure		2013-04-13 12:58:28	
Removal:	0.0%		
Square:	No		
Pressure-Diff Scale:	4.00	20.00	
Pressure-Diff Unit:	KPa		
Flow unit:	t/h		
Actual Temperature:	Input	Chnl02	°C
Actual Pressure:	Input	Chnl03	Mpa
Designed Temperature:	0 °C		
Designed Pressure:	0 MPa		
Finish			

1. Resection of the small signal

The setting range is 0.0-9.9%, expressed by a percentage. If Input differential signal is less than set value range, it will be the limit input. To adjust settings with [Up and Down] keys

2. Square root

To have square root calculation on the percentage of the differential pressure signal. To adjust settings with [Up and Down] keys

3. Differential pressure range

To acquire differential signal to display range. Press [En] key to modify the settings. To adjust settings with [Up and Down] keys

4. Differential pressure units

Differential pressure signal units are involved in operations. It is fixed at KPa.

5. Flow units

Flow units is involved in operations, the default is t / h (or t / h, kg / h). Press [up and down] key to select.

6. Temperature conditions

Input type: [enter], [set] (two options).

[Input]: Select the signal channel input for the temperature value, press [up and down] key to select.

[Set]: Set the constant value for temperature. Press [En] button to change settings, press [up and down] key to adjust.

7. Pressure condition

Input type: [enter], [set] (two options).

[Input]: Select the signal channel input for the pressure value, press [up and down] key to select.

[Set]: Set the constant value for pressure. Press [En] button to change settings, press [up and down] key to adjust.

8. Set temperature

Set temperature value. Press [En] button to change settings, press [up and down] key to adjust.

9. Design pressure

Set pressure value. Press [En] button to change settings, press [up and down] key to adjust.

10. Cursor to the [Finish] button, press the [En] button to return.

Orifice + Water Parameter Setting

This section describes measuring device (orifice) and measuring medium (water) parameters setting.

Operating

Press the [page] + [En], enter the configuration menu.

Use the [arrow keys] and [En] button, enter the password, and then select to enter the [flow compensation].

Move the cursor to the [Parameter setting] button, press the [En] key to enter the parameter-setting screen.

Configure		2013-04-13 12:58:28	
Removal:	0.0%		
Square:	No		
Pressure-Diff Scale:	4.00	20.00	
Pressure-Diff Unit:	KPa		
Flow unit:	t/h		
Actual Temperature:	Input	Chnl02	°C
Actual Pressure:	0.6MPa		
Designed Temperature:	0 C		
Finish			

1. Resection of the small signal

The setting range is 0.0-9.9%, expressed by a percentage. If Input differential signal is less than set value range, it will be the limit input. To adjust settings with [Up and Down] keys

2. Square root

To have square root calculation on the percentage of the differential pressure signal. To adjust settings with [Up and Down] keys

3. Differential pressure range

To acquire differential signal to display range. Press [En] key to modify the settings. To adjust settings with [Up and Down] keys

4. Differential pressure units

Differential pressure signal units are involved in operations. It is fixed at KPa.

5. Flow units

Flow units is involved in operations, the default is t / h (or t / h, kg / h). Press [up and down] key to select.

6. Temperature conditions

Input type: [enter], [set] (two options).

[Input]: Select the signal channel input for the temperature value, press [up and down] key to select.

[Set]: Set the constant value for temperature. Press [En] button to change settings,

press [up and down] key to adjust.

7. Pressure condition

Input type: [enter], [set] (two options).

[Input]: Select the signal channel input for the pressure value, press [up and down] key to select.

[Set]: Set the constant value for pressure. Press [En] button to change settings, press [up and down] key to adjust.

8. Set temperature

Set temperature value. Press [En] button to change settings, press [up and down] key to adjust.

9. Cursor to the [Finish] button, press the [En] button to return.

Orifice + General Gas Parameter Setting

This section describes measuring device (orifice) and measuring medium (general gas) parameters setting.

Operating

Press the [page] + [En], enter the configuration menu.

Use the [arrow keys] and [En] button, enter the password, and then select to enter the [flow compensation].

Move the cursor to the [Parameter setting] button, press the [En] key to enter the parameter-setting screen.

Configure		2013-04-13 12:58:28	
Removal:	0.0%	Square:	No
Pressure-Diff Scale:	4.00		20.00
Pressure-Diff Unit:	KPa		
Flow unit:	t/h		
Actual Temperature:	Input	Chnl02	°C
Actual Pressure:	Input	Chnl03	MPa
Designed Temperature:	0 C		
Designed Pressure:	0 MPa		
Compress Rate:	Table	Air	
Local atm:	0.1013Mpa		
Finish			

1. Resection of the small signal

The setting range is 0.0-9.9%, expressed by a percentage. If Input differential signal is less than set value range, it will be the limit input. To adjust settings with [Up and Down] keys

2. Square root

To have square root calculation on the percentage of the differential pressure signal. To adjust settings with [Up and Down] keys

3. Differential pressure range

To acquire differential signal to display range. Press [En] key to modify the settings. To adjust settings with [Up and Down] keys

4. Differential pressure units

Differential pressure signal units are involved in operations. It is fixed at KPa.

5. Flow units

Flow units are involved in operations. It is fixed at m³/h.

6. Temperature conditions

Input type: [enter], [set] (two options).

[Input]: Select the signal channel input for the temperature value, press [up and down] key to select.

[Set]: Set the constant value for temperature. Press [En] button to change settings, press [up and down] key to adjust.

7. Pressure condition

Input type: [enter], [set] (two options).

[Input]: Select the signal channel input for the pressure value, press [up and down] key to select.

[Set]: Set the constant value for pressure. Press [En] button to change settings, press [up and down] key to adjust.

8. Set temperature

Set temperature value. Press [En] button to change settings, press [up and down] key to adjust.

9. Designed pressure

Set design pressure value. Press [En] button to change settings, press [up and down] key to adjust.

10. Compressibility coefficient

General gas's compressibility coefficient. There are [set], [check] two options.

[Settings]: free to set the compression factor. Press [En] button to change settings, press [up and down] key to adjust.

[Check]: There are three kinds of gas models: air, nitrogen, oxygen, and press [up and down] key to select.

11. The local atmospheric pressure

Atmospheric pressure where the user locates. Press [En] button to change settings, press [up and down] key to adjust.

12. Cursor to the [Finish] button, press the [En] button to return.

Vortex (Frequency) + Steam Parameter Setting

This section describes measuring device (vortex) and measuring medium (steam) parameters setting.

Operating

Press the [page] + [En], enter the configuration menu.

Use the [arrow keys] and [En] button, enter the password, and then select to enter the [flow compensation].

Move the cursor to the [Parameter setting] button, press the [En] key to enter the parameter-setting screen.

Configure		2013-04-13 12:58:28	
Removal:	<input type="text" value="0%"/>		
K:	<input type="text" value="1"/>		
Unit of K:	<input type="text" value="Times/m<sup>3</sup>"/>		
Flow Unit:	<input type="text" value="t/h"/>		
Actual temperature:	<input type="text" value="Input"/>	<input type="text" value="Chnl02"/>	<input type="text" value="°C"/>
Actual pressure:	<input type="text" value="Input"/>	<input type="text" value="Chnl03"/>	<input type="text" value="MPa"/>
			<input type="button" value="Finish"/>

1. Resection of the small signal

The setting range is 0.0-9.9%, expressed by a percentage. If Input differential signal is less than set value range, it will be the limit input. To adjust settings with [Up and Down] keys

2. K Vortex average K factor setting.

Press [En] key to modify the settings. . To adjust settings with [Up and Down] keys.

3. K factor unit

K factor unit is involved in operation.

The default is time / m3 (optional times / m3, plays / L). To adjust settings with [Up and Down] keys

4. Flow units

Traffic units involved in operations, the default is t / h (optional t / h, kg / h), press [up and down] key to select.

5. Temperature conditions

Input type: [enter], [set] (two options).

[Input]: Select the signal channel input for the temperature value, press [up and down] key to select.

[Set]: Set the constant value for temperature. Press [En] button to change settings, press [up and down] key to adjust.

6. Pressure condition

Choose [0.6MPa] or [1.6Mpa]. Press [up and down] key to select.

7. Cursor to the [Finish] button, press the [En] button to return.

Vortex (Frequency) + Water Parameter Setting

This section describes the measuring device (vortex (frequency) and measured medium (water) parameter settings.

Operation

Press the [page] + [En], enter the configuration menu.

Use the [arrow keys] and [En] button, enter the password, and then select to enter The [flow compensation].

Move the cursor to the [Parameter setting] button, press the [En] key to enter the parameter-setting screen.

Configure		2013-04-13 12:58:28	
Removal:	<input type="text" value="0%"/>		
K:	<input type="text" value="1"/>		
Unit of K:	<input type="text" value="Times/m<sup>3</sup>"/>		
Flow Unit:	<input type="text" value="t/h"/>		
Actual temperature:	<input type="text" value="Input"/>	<input type="text" value="Chnl02"/>	<input type="text" value="°C"/>
Actual pressure:	<input type="text" value="0.6MPa"/>		
<input type="button" value="Finish"/>			

1. Resection of the small signal

The setting range is 0.0-9.9%, expressed by a percentage. If Input differential signal is less than set value range, it will be the limit input. To adjust settings with [Up and Down] keys

2. K Vortex average K factor setting.

Press [En] key to modify the settings. . To adjust settings with [Up and Down] keys

3. K factor unit

K factor unit is involved in operation.

The default is time / m³ (optional times / m³, plays / L). To adjust settings with [Up and Down] keys

4. Flow units

Traffic units involved in operations, the default is t / h (optional t / h, kg / h), press [up and down] key to select.

5. Temperature conditions

Input type: [enter], [set] (two options).

[Input]: Select the signal channel input for the temperature value, press [up and down] key to select.

Vortex (Frequency) + General Gas Parameter Setting

This section describes the measuring device (vortex (frequency) and measured medium (general gas) parameter settings.

Operation

Press the [page] + [En], enter the configuration menu.

Use the [arrow keys] and [En] button, enter the password, and then select to enter the [flow compensation].

Move the cursor to the [Parameter setting] button, press the [En] key to enter the parameter-setting screen.

Configure		2013-04-13 12:58:28	
Removal:	<input type="text" value="0%"/>		
K:	<input type="text" value="1"/>		
Unit of K:	<input type="text" value="Times/m<sup>3</sup>"/>		
Flow Unit:	<input type="text" value="t/h"/>		
Actual temperature:	<input type="text" value="Input"/>	<input type="text" value="Chnl02"/>	<input type="text" value="°C"/>
Actual pressure:	<input type="text" value="Input"/>	<input type="text" value="Chnl03"/>	<input type="text" value="MPa"/>
Compress Rate:	<input type="text" value="Table"/>	<input type="text" value="Air"/>	
Local atm pressure:	<input type="text" value="0.1013MPa"/>		
			<input type="button" value="Finish"/>

1. Resection of the small signal

The setting range is 0.0-9.9%, expressed by a percentage. If Input differential signal is less than set value range, it will be zero. To adjust settings with [Up and Down] keys.

2. K Vortex average K factor setting.

Press [En] key to modify the settings. . To adjust settings with [Up and Down] keys.

3. K factor unit

K factor unit is involved in operation.

The default is time / m³ (optional times / m³, plays / L). To adjust settings with [Up and Down] keys.

4. Flow units

Flow units are involved in operations. It is fixed at m³/h.

5. Temperature conditions

Input type: [enter], [set] (two options).

[Input]: Select the signal channel input for the temperature value, press [up and down] key to select.

[Set]: Set the constant value for temperature. Press [En] button to change settings, press [up and down] key to adjust.

6. Pressure condition

Input type: [enter], [set] (two options).

[Input]: Select the signal channel input for the pressure value, press [up and down] key to select.

[Set]: Set the constant value for pressure. Press [En] button to change settings, press [up and down] key to adjust.

7. Compressibility coefficient

General gas's compressibility coefficient. There are [set], [check] two options.

[Settings]: free to set the compression factor. Press [En] button to change settings, press [up and down] key to adjust.

[Check]: There are three kinds of gas models: air, nitrogen, oxygen, and press [up and down] key to select.

8. The local atmospheric pressure

Atmospheric pressure where the user locates. Press [En] button to change settings, press [up and down] key to adjust.

9. Cursor to the [Finish] button, press the [En] button to return.

Vortex (mA) + Steam Parameter Setting

This section describes the measuring device (vortex (ma) and measured medium (steam) parameter settings.

Operation

Press the [page] + [En], enter the configuration menu.

Use the [arrow keys] and [En] button, enter the password, and then select to enter the [flow compensation].

Move the cursor to the [Parameter setting] button, press the [En] key to enter the parameter-setting screen.

Configure		2013-04-13 12:58:28	
Removal:	<input type="text" value="0%"/>		
Volume Scale:	<input type="text" value="4.00"/>	<input type="text" value="20.00"/>	
Volume Unit:	<input type="text" value="m<sup>3</sup>/h"/>		
Flow Unit:	<input type="text" value="t/h"/>		
Actual temperature:	<input type="text" value="Input"/>	<input type="text" value="Chnl02"/>	<input type="text" value="°C"/>
Actual pressure:	<input type="text" value="Input"/>	<input type="text" value="Chnl03"/>	<input type="text" value="MPa"/>
			<input type="button" value="Finish"/>

1. Resection of the small signal

The setting range is 0.0-9.9%, expressed by a percentage. If Input differential signal is less than set value range, it will be input limit. To adjust settings with [Up and Down] keys

2. Volume Range

Collect display range of volume signal, and press [En key to modify the settings, and press [up and down] key to adjust.

3. Volume unit

Volume unit is involved in operations, fixed at m³ / h.

4. Flow units

Flow units is involved in operations, the default is t / h (optional t / h, kg / h), press [up and down] key to select.

5. Temperature conditions

Input type: [enter], [set] (two options).

[Input]: Select the signal channel input for the temperature value, press [up and down] key to select.

[Set]: Set the constant value for temperature. Press [En] button to change settings, press [up and down] key to adjust.

6. Pressure condition

Input type: [enter], [set] (two options).

[Input]: Select the signal channel input for the pressure value, press [up and down] key to select.

[Set]: Set the constant value for pressure. Press [En] button to change settings, press [up and down] key to adjust.

7. Cursor to the [Finish] button, press the [En] button to return.

Vortex (mA) + Water Parameter Setting

This section describes the measuring device (vortex (ma) and measured medium (water) parameter settings.

Operation

Press the [page] + [En], enter the configuration menu.

Use the [arrow keys] and [En] button, enter the password, and then select to enter The [flow compensation].

Move the cursor to the [Parameter setting] button, press the [En] key to enter the parameter-setting screen.

Configure		2013-04-13 12:58:28	
Removal:	<input type="text" value="0%"/>		
Volume Scale:	<input type="text" value="4.00"/>	<input type="text" value="20.00"/>	
Volume Unit:	<input type="text" value="m<sup>3</sup>/h"/>		
Flow Unit:	<input type="text" value="t/h"/>		
Actual temperature:	<input type="text" value="Input"/>	<input type="text" value="Chn102"/>	<input type="text" value="°C"/>
Actual pressure:	<input type="text" value="0.6MPa"/>		
			<input type="button" value="Finish"/>

1. Resection of the small signal

The setting range is 0.0-9.9%, expressed by a percentage. If Input differential signal is less than set value range, it will be input limit. To adjust settings with [Up and Down] keys.

2. Volume Range

Collect display range of volume signal, and press [En key to modify the settings, and press [up and down] key to adjust.

3. Volume unit

Volume unit is involved in operations, fixed at m³ / h.

4. Flow units

Flow units is involved in operations, the default is t / h (optional t / h, kg / h), press [up and down] key to select.

5. Temperature conditions

Input type: [enter], [set] (two options).

[Input]: Select the signal channel input for the temperature value, press [up and down] key to select.

[Set]: Set the constant value for temperature. Press [En] button to change settings, press [up and down] key to adjust.

6. Pressure condition

Input type: [enter], [set] (two options).

Choose [0.6MPa] or [1.6Mpa], and press [up and down] key to adjust.

7. Cursor to the [Finish] button, press the [En] button to return.

Vortex (mA) + General Gas Parameter Setting

This section describes the measuring device (vortex (ma) and measured medium (general gas) parameter settings.

Operation

, enter the configuration menu.

Use the [arrow keys] and [En] button, enter the password, and then select to enter the [flow compensation].

Move the cursor to the [Parameter setting] button, press the [En] key to enter the parameter-setting screen.

Configure		2013-04-13 12:58:28	
Removal:	<input type="text" value="0%"/>		
Volume Scale:	<input type="text" value="4.00"/>	<input type="text" value="20.00"/>	
Volume Unit:	<input type="text" value="m<sup>3</sup>/h"/>		
Flow Unit:	<input type="text" value="t/h"/>		
Actual temperature:	<input type="text" value="Input"/>	<input type="text" value="Chnl02"/>	<input type="text" value="°C"/>
Actual pressure:	<input type="text" value="Input"/>	<input type="text" value="Chnl03"/>	<input type="text" value="MPa"/>
Compress Rate:	<input type="text" value="Table"/>	<input type="text" value="Air"/>	
Local atm pressure:	<input type="text" value="0.1013MPa"/>		
			<input type="button" value="Finish"/>

1. Resection of the small signal

The setting range is 0.0-9.9%, expressed by a percentage. If Input differential signal is less than set value range, it will be zero. To adjust settings with [Up and Down] keys.

2. Volume Range

Collect display range of volume signal, and press [En key to modify the settings, and press [up and down] key to adjust.

3. Volume unit

Volume unit is involved in operations, fixed at m³ / h.

4. Flow units

Flow units are involved in operations. It is fixed at m³/h.

5. Temperature conditions

Input type: [enter], [set] (two options).

[Input]: Select the signal channel input for the temperature value, press [up and down] key to select.

[Set]: Set the constant value for temperature. Press [En] button to change settings, press [up and down] key to adjust.

6. Pressure condition

Input type: [enter], [set] (two options).

[Input]: Select the signal channel input for the pressure value, press [up and down] key

to select.

[Set]: Set the constant value for pressure. Press [En] button to change settings, press [up and down] key to adjust.

7. Compressibility coefficient

General gas's compressibility coefficient. There are [set], [check] two options.

[Settings]: free to set the compression factor. Press [En] button to change settings, press [up and down] key to adjust.

[Check]: There are three kinds of gas models: air, nitrogen, oxygen, and press [up and down] key to select.

8. The local atmospheric pressure

Atmospheric pressure where the user locates. Press [En] button to change settings, press [up and down] key to adjust.

9. Cursor to the [Finish] button, press the [En] button to return.

Chapter 12 PID Function(Optional)

12.1 Setting specifications of PID

This section describes the PID function parameter settings.

The screenshot shows a configuration window for the PID function. The title bar is blue with the text 'PID' on the left and '2017-08-25 20:10:23' on the right. The main area is light gray and contains several rows of settings, each with a label, a value, and a dropdown arrow. The settings are: LOOP: LOOP1; Input: Chn1; P: 100; I: 30; D: 0; MVL: 0.0; MVH: 100.0; Output: MV; FeedBack: NEG; Cycle: 1s; AT: Disable. At the bottom right, there is a button labeled 'Exit'.

1. LOOP: Select loop, LOOP1~LOOP4.
2. Input: Choose the PV channel, choose 1~8 channel.
3. PID: PID parameter.
Proportion Pb%: 1-999.9%
Integration Ti: 1-9999s
Differentiation Td: 0-9999s (Td=0, Differentiation no use)
4. MVL: Threshold output limit of valve position: when the valve position output is below the limit, use the limit value.
5. MVH: Threshold output limit of valve position: when the valve position output is higher than the limit, use the limit value.
6. Output: two types of circuit output and output can be selected. Select "MV" to output as loop output. When selecting a channel, the output is the transformation output for the channel.
7. Execution: select valve opening and closing. "Positive feedback" and "negative feedback" can be selected.
8. Cycle: the reaction instrument operation can be adjusted quickly, and the 1s - 30s can be set.
9. AT: the instrument provides two options: "Enable" and "Disable".

Chapter 13 Setting Report(Optional)

13.1 Setting specifications of report

Procedure

Press [Page] and [En] at the same time, enter the configuration menu.

Use arrow keys and [En] to input the password, enter the [Report] screen.

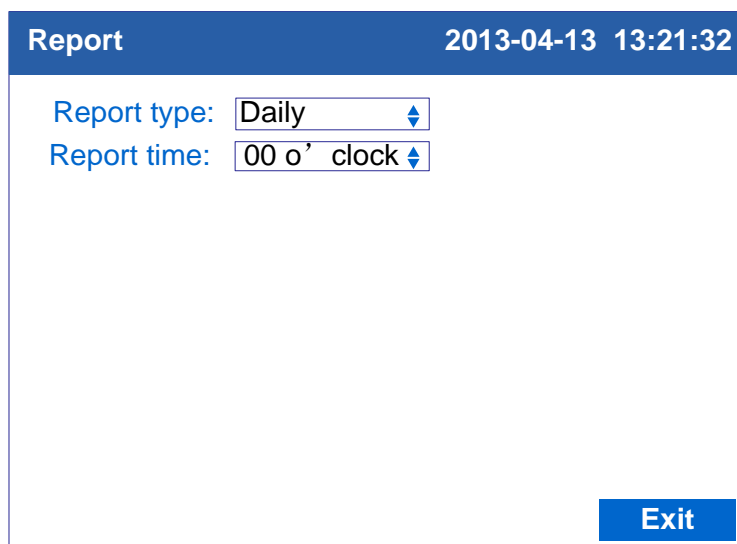

The screenshot shows a configuration window titled 'Report' with a date and time of '2013-04-13 13:21:32'. Inside the window, there are two dropdown menus. The first is labeled 'Report type:' and is currently set to 'Daily'. The second is labeled 'Report time:' and is currently set to '00 o'clock'. In the bottom right corner of the window, there is a blue button labeled 'Exit'.

1. Report type

Select report type for display and saving, there are four options: Hourly, 8Hourly, 12Hourly and Daily (you can get into the Report-Monthly screen while at the screen of Report-Daily)

2. Report time

Setting report time. Using [Up] or [Down] key to Configure the report time from 00 o'clock to 07 o'clock.

Confirming operation

After the parameter setting, select [Exit] there is a Frame.

Select [Yes] to save setting content, and exit [Report] screen.

Select [No] to cancel setting content, and exit [Report] screen.

Select [Cancel] to continue setting parameters in [Report] screen.

Warning

Do not change the report type at will; the change will cause the internal data to be chaotic.

Chapter 14 Communication Function(Optional)

14.1 Setting Device Address

Procedure

[Configuration Menu] -> [Communication]

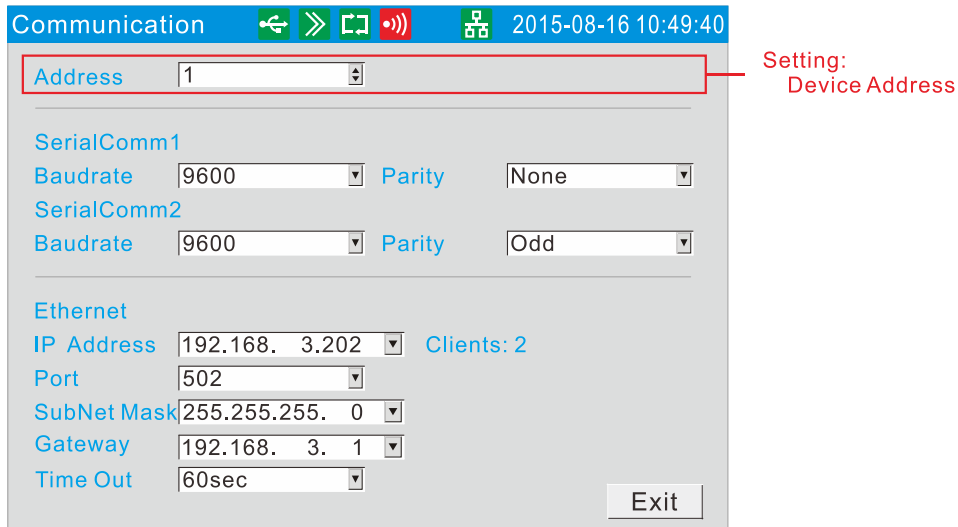

Parameter

1. Device Address: Modbus device address, ranging from 1 to 247.

Explanation

1. Connects communication wiring.
2. Setting the instrument's communication address, baud rate, parity.
3. The setting of the PC's communication address, baud rate and parity are the same of the instruments.
4. Use it.

The port of RS232C is DB9. Where,
2 → RXD, 3 → TXD, 5 → GND

14.2 Setting COM Parameters

Procedure

[Configuration Menu] -> [Communication]

Communication 2015-08-16 10:49:40

Address 1

SerialComm1
Baudrate 9600 Parity None

SerialComm2
Baudrate 9600 Parity Odd

Ethernet
IP Address 192.168. 3.202 Clients: 2
Port 502
SubNet Mask 255.255.255. 0
Gateway 192.168. 3. 1
Time Out 60sec

Exit

Com Setting:
Baudrate
Parity

Parameter

1. **Baud rate:** 1200,2400,4800,9600,19200,38400,57600,115200.
The default value is 9600.
2. **Parity:** Serial communication check. Parity: no parity, odd parity, even parity.
The default value is none.

14.3 Modbus-RTU protocol

Modbus based on serial communication run on the RS-232 or RS-485 bus, and in RTU mode, each byte format is:

- 1 Start bit
- 8 data bit, the lowest valid bit is sent first
- 1 parity bit, no parity is none
- 1 Stop bit

In Modbus based on serial communication, the additional address domain uses a 1-byte slave station address, and the data verification domain uses a 2-byte CRC check, the frame format is as follows:

Slave station address (1byte)	Function code (1byte)	Data (0~252byte)	CRC check (2byte)
----------------------------------	--------------------------	---------------------	----------------------

For example:

Ask: 01 04 00 00 00 01 31 CA

Slave station address	Function code	Data		CRC check (LSB)
		Register address	The number of registers	
01	04	00 00	00 01	31 CA

Response: 01 04 02 00 64 B8 DB

Slave station address	Function code	Data		CRC check (LSB)
		The number of bytes	Register data	
01	04	02	00 64	B8 DB

14.4 Setting Ethernet Parameters

Procedure

[Configuration Menu] -> [Communication]

The screenshot shows a 'Communication' configuration window with a title bar containing navigation icons and a timestamp '2015-08-16 10:49:40'. The window is divided into sections for 'Address', 'SerialComm1', 'SerialComm2', and 'Ethernet'. The 'Ethernet' section is highlighted with a red border. A red arrow points from the text 'Ethernet Setting: IP Address, Port, Mask, Gateway, Timeout' to the 'Ethernet' section.

Field	Value
Address	1
SerialComm1 Baudrate	9600
SerialComm1 Parity	None
SerialComm2 Baudrate	9600
SerialComm2 Parity	Odd
Ethernet IP Address	192.168. 3.202
Ethernet Port	502
Ethernet SubNet Mask	255.255.255. 0
Ethernet Gateway	192.168. 3. 1
Ethernet Time Out	60sec

Ethernet Setting:
 IP Address
 Port
 Mask
 Gateway
 Timeout

Parameter

1. **IP Address:** It is the only address of each different internet devices, which is used for distinguishing devices.
2. **Port:** Software port number for Ethernet connects. The default value is 502.
3. **Mask:** It is set according to different IP address. Default mask: 255.255.255.0.
4. **Gateway:** The address of gateway.
5. **Timeout:** The connections retry intervals.

14.5 Modbus/TCP protocol

Modbus TCP runs on the TCP/IP network and all Modbus TCP frames are emitted via TCP register port 502.

When Modbus is applied to TCP/IP, the additional address domain uses a dedicated message header to identify the Modbus application data unit, which is called the MBAP message header(Modbus protocol message header). In addition, there is no data verification domain on TCP/IP, the accuracy of the transmitted data is verified by the TCP/IP and link layer (Ethernet) verification mechanism, the frame format is as follows:

MBAP prefix (7byte)	Function code (1byte)	Data (0~252byte)
------------------------	--------------------------	---------------------

The MBAP prefix (Modbus Application Protocol header) format is as follows:

Domain	Length	Description
The thing meta-identifier	2 byte	An identifier for request/response trans-action processing, which is used for transaction pairing. The configuration is initialized by the requester, then responder copies the transaction identifier of the request.
Protocol identifier	2 byte	0 identified as the Modbus protocol.
Length	2 byte	Subsequent data bytes, including cell identifiers, function codes, and data.
Cell identifier	1 byte	The identification number of a remote slave station connected on a serial link or other bus is generally the slave station address of a meter.

For example:

Request: 00 00 00 00 06 01 04 00 00 00 01

MBAP prefix				Function code	Data	
					Register address	The number of registers
00	00	00	01	04	00 00	00 01
00	00	06				

Response: 00 00 00 00 05 01 02 00 64

MBAP prefix				Function code	Data	
					The number of bytes	Register data
00	00	00	01	04	02	00 64
00	00	05				

14.6 Register address of the instrument

1. Quantity (floating point):

Channel	1	2	3	4	5	6	7	8
Address	00	02	04	06	08	10	12	14
Channel	9	10	11	12	13	14	15	16
Address	16	18	20	22	24	26	28	30

2. Quantities (percentage):

Channel	1	2	3	4	5	6	7	8
Address	32	33	34	35	36	37	38	39
Channel	9	10	11	12	13	14	15	16
Address	40	41	42	43	44	45	46	47

3. Accumulation (unsigned long):

Channel	1	2	3	4	5	6	7	8
Address	112	114	116	118	120	122	124	126
Channel	9	10	11	12	13	14	15	16
Address	128	130	132	134	136	138	140	142

Note: The actual cumulative volume = Read accumulation (ulong)

Chapter 15 Set Printing Configuration(Optional)

15.1 Connect with Micro Printer(Optional)

The instrument can connect with the micro printer.

Procedure

The screenshot shows a configuration window titled 'Print' with a timestamp '2013-04-10 13:21:32'. It contains the following fields and buttons:

- Time range:** 2013-04-07 17:53:37 to 2013-04-10 13:21:32 (labeled 1)
- Start time:** 2008-03-07 17:53:37 (dropdown arrow) (labeled 2)
- End time:** 2008-03-10 13:21:32 (dropdown arrow) (labeled 3)
- Channel:** Chnl01 (dropdown arrow) (labeled 4)
- Interval:** 1 (dropdown arrow) (labeled 5)
- Buttons:** 'Print data' (labeled 6), 'Print curve' (labeled 7), and 'Seek printer' (labeled 8)
- Status bar:** 'Please check the printer!' (labeled 9)

1. The printer's time range
2. Set the printer's start time
3. Set the printer's end time
4. Select the print channel
5. Set the interval
6. Print the data
7. Print the trend
8. Seek the connection printer
9. The printer state.

Explanation

Use the RS232C port to connect the instrument and the printer

Port	Printer port
RXD	RTS
TXD	RXD
GND	GND

Set the printer's communication parameter (the instrument doesn't need)

Baud rate	9600
Start bit	1
Data bit	8
Parity	None

15.2 Auto Print Function Setting

Procedure

Press [Page] and [En] at the same time, enter the configuration menu.

Use arrow keys and [En] to input the password, enter the [Timer] screen.

The screenshot shows the 'Timer' configuration menu. At the top, it says 'Timer' and '2013-04-10 13:21:32'. Below this are several settings, each with a dropdown arrow on the right. The settings are: 'TimerPrt : Yes', 'The Time: 18:23 (H: M)', 'Interval : 01:12 (H: M)', 'Key Prt : Yes', 'Print Blank : Yes', and 'Print Type : All'. A blue 'Exit' button is located at the bottom right. Six numbered callouts (1-6) are on the right side of the screen, each pointing to one of the settings.

1. Set the timer print function
[Yes]: The timer print function is opened.
[No]: The timer print function is closed.
2. The starting time
3. Interval: Between two printing time intervals.
4. Key Prt: In the digital display screen, Bar graph screen, real-time curve screen, using the [Left] to trigger button printing, and then print the real-time data and cumulative amount.
5. Print Blank: After it is turned on, an additional blank will be printed to ensure that the paper at the printer outlet contains all printed data.
6. Print Type: Adjust the print type: All, Value and Accu.

Confirming operation

After the parameter setting, select [Exit] there is a Frame.

Select [Yes] to save setting content, and exit [Timer] screen.

Select [No] to cancel setting content, and exit [Timer] screen.

Select [Cancel] to continue setting parameters in [Timer] screen.

Note

- When use the timer print function, the printer must connect with the instrumental the time.
 - About the printer setting, see section 10.3.
-

Chapter 16 System Information and Upgrade

16.1 Check System Information

Procedure

Press [Page] and [En] to enter configuration menu.

Use arrow keys and [En] to input the password, enter the [About] screen.

Explanation

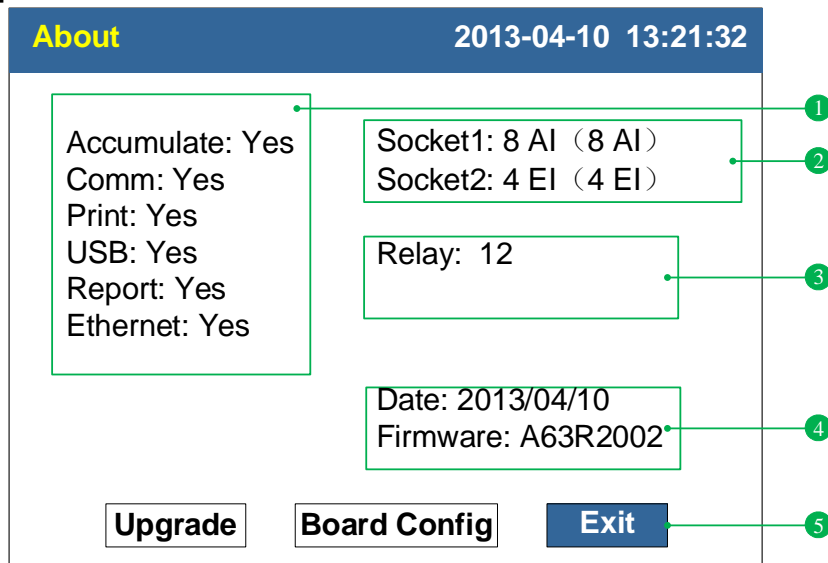

1. The Option Functions
2. The number and type of the hardware in-out channels.
3. The output loop of the relay
4. The Firmware issue date and version number
5. [Exit] soft key

16.2 Upgrade

This section describes the program upgrade through U disk.

Procedure

Put the program file (such as A63R2. img) provided by the manufacturer into the U disk, and insert the U disk into the USB socket of the instrument to be upgraded.

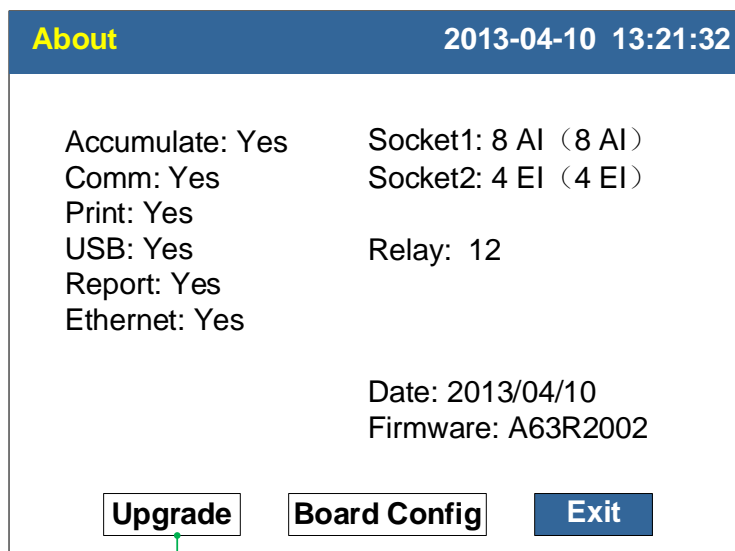

1. Enter system Configuration screen[About]and choose[Upgrade].
2. The red letter [firmware file has been found!] is displayed below, and a prompt window will pop up. After checking and confirming that the original firm and the upgraded firm are correct, select [Yes].

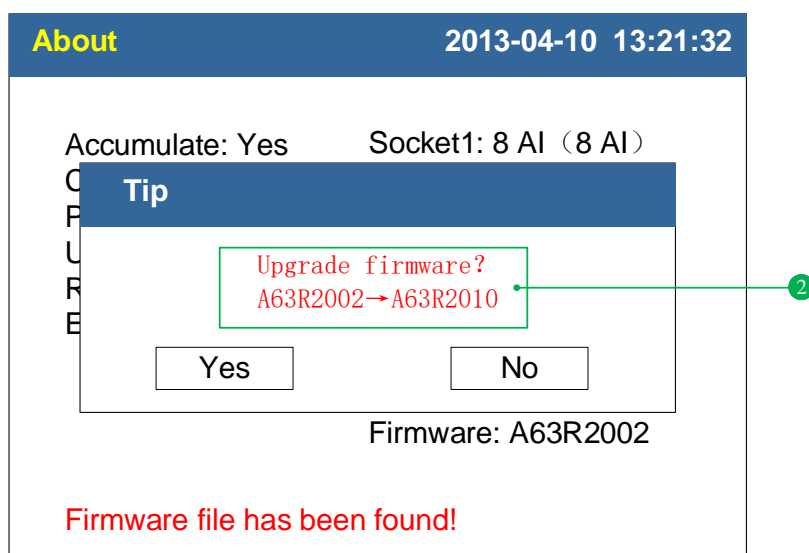

3. Wait until the firmware upgrade is completed, restart the instrument, return to the [About] interface, confirm that the firmware version has been updated, and unplug the U disk.

Chapter 17 Initializing Data

17.1 Restore Factory Setting

Procedure

[Configuration Menu] -> [Communication]

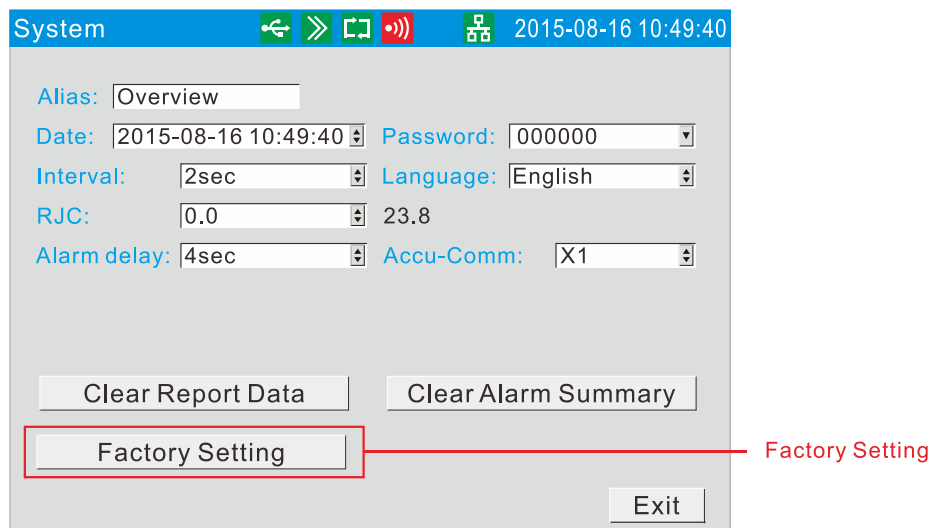

Operation

Restore factory setting

Move the cursor to [Factory Setting], press [En].

Note

After factory setting, the historical data stored in instrument will be cleared.
Before the factory setting, please backup the historical data.

Explanation

The influencing parameter tabulation

Type	Name	Value
System parameter	Alias	Overview
	Password	000000
Display parameter	Direction	Horizontal
	Group1	Enable Group1 – Chn1 – purple Group2 – Chn2 – green Group3 – Chn3 – blue Group4 – Chn4 – yellow
	Group2 – 4	Prohibited
Data save parameter	Interval	02 S
Communication parameter	Address	8
	Baud rate	9600
	Parity	None
Print parameter	Timer print	No
	Start time	00:00
	Timer interval	01:00
	Key printing	No
	Print Blank	No
	Print Type	All
Analog input parameter (all channels)	Tag	Channel [No.]
	Type	4-20mA
	Unit	%
	lower limit	4.00
	Upper limit	20.00
	Accumulation	No
	Accumulation rate	1
	Vacuum	No
	Filter	0.0 sec.
	Burnout	Minimum
	Cold junction adjustment	0.0
	Square	No
	Cut	0.0%
	Adjust value K	1.00
	Adjust value B	0.00
Alarm parameter (all channels)	Alarm low-low threshold	4.00
	Alarm low threshold	4.00
	Alarm high threshold	20.00
	Alarm high-high threshold	20.00
	Alarm contact(all alarm))	0
	Zone	0.00
Analog output parameter (all loops)	Analog output	No
	Adjust value K	1.00
	Adjust value B	0.00

17.2 Purge Alarm Summary

Procedure

[Configuration Menu] -> [Communication]

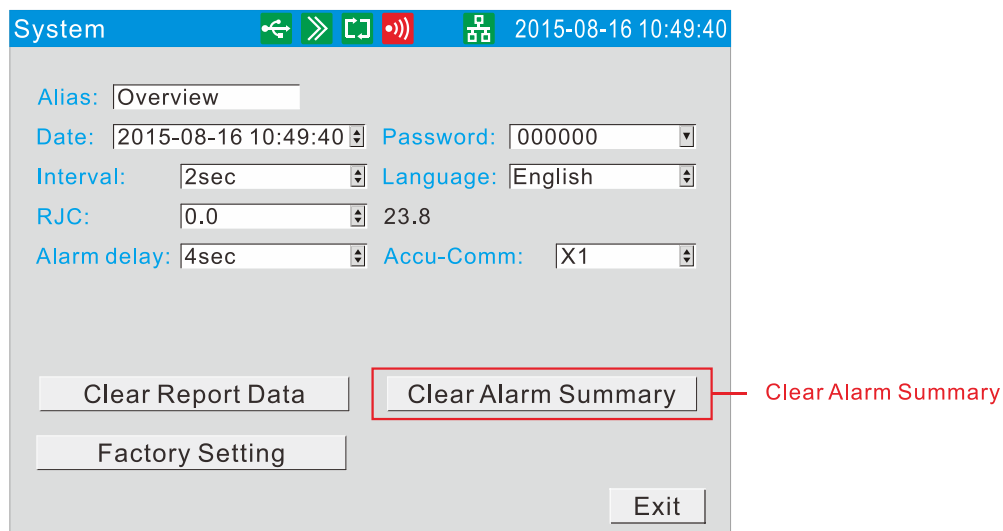

Operation

Move the cursor to [Clear Alarm Summary], press [En].

Note

Clearing alarm list will eliminate alarm records in memory, and cannot be recovered.

Clearing alarm list will not affect other parameters and functions of this instrument.

17.3 Purge Accumulation Data

Procedure

[Configuration menu] -> [Input]

Input 2015-08-16 10:49:40

Channel: 1 Tag: ChnI01
 Type: Sin Unit: t/h
 Range: 4.00 20.00 Filter: 0.0s
 Vacuum: No Cut: 0.0% Sqrt: No
 Burnout Set: Minimize Frequency: 1
 Accumulate: No Acc.Magnification: 1

	LL	L	H	HH	Zone
Value	5.00	6.00	18.00	19.00	1
Relay	1	2	3	4	

K=: 1.00 B=: 0.00 **Clear Acc** Copy01 Exit

PurgeAccumulate

Operation

Clear Accumulate

Move the cursor to [Clear Acc], press [En] key.

Explanation

Clearing accumulation will eliminate accumulation records in memory, and cannot be recovered.

Clearing accumulation will not affect other parameters and functions of this instrument.

Chapter 18 Specifications

18.1 Signal and Alarm Specifications

Measures input

Item	Specification
Number of input channels	Measuring 12 channels at the same time(maximum)
Scan Interval	1 second
Signal types	DC current(I)、Volt(V)、thermocouple(TC)、resistance temperature detector(RTD)、frequency(FR)

Measure range

Input type	Range	Measuring range
Current	4-20mA	4.00mA ~ 20.00mA
	0-10mA	0.00mA ~ 10.00mA
Volt	1-5V	1.000V ~ 5.000V
	0-5V	0.000V ~ 5.000V
	0-10V	0.000V ~ 10.000V
	20mV	0.00mV ~ 20.00mV
	100mV	0.00mV ~ 100.00mV
Resistance	350Ω	0.0Ω ~ 350.0Ω
Frequency	FR	0Hz ~ 10000Hz
RTD	PT100	-200.0°C~650.0°C
	Cu50	-50.0°C~140.0°C
	Cu53	-50.0°C~150.0°C
	BA1	-100°C~600°C
	BA2	-100°C~600°C
TC	S	-100°C~1600°C
	R	-50°C~1600°C
	B	500°C~1800°C
	K	-50°C~1300°C
	N	-200°C~1300°C
	E	-100°C~1000°C
	J	-100°C~1000°C
	T	-100°C~380°C
	WRE5-26	0°C~2310°C
	WRE3-25	0°C~2315°C
	F1	600°C~2000°C
	F2	600°C~2000°C

Measuring current: I = 0.5mA(Resistance、RTD)

Thermocouple burnout	Select the displays of MAX,MIN, Error sign and Keep the anterior values Standard: ≤2kΩ, burnout: ≥100kΩ Measuring current: about 2.5uA
-------------------------	--

Item	Specification
The thermocouple reference junction compensation	Use the interior reference junction compensation , compensation precision $\pm 0.5^{\circ}\text{C}$
Digital filtering	0~9.9 seconds inertia filter
Vacuum operation	
Common arithmetic	Use the LOG trend operation in the whole range
Subsection arithmetic	Use the linearity operation at each subsection

Alarm

Parameter	Specification
Number of alarms	Up to four alarms for each channel
Alarm types	Ultra Upper limit alarm Upper limit alarm Lower limit alarm Ultra Lower limit alarm
Alarm delay time	Selectable from 1s to 3600s for each channel
Alarm output	Output to the interior relay Number of the normally open relay: 8 Or 12 (If the channel number is more than 12, it is 8, otherwise, it is 12) Number of the normally closed relay: 6 The interior relay operation: OR operation
Display	When has alarming, in corresponding screen display alarm condition, in Status Display Section display alarm icon
Alarm information	Display the alarm log that occurred in the alarm summary

18.2 Display Specifications

Display

Item	Specification
Display*	5.6" TFT color LCD (234-by-320 dot resolution)

* LCD display may have some pixels light or dark, because of the difference function of LCD, and the LCD brightness possibly is also dissimilar, but these are not malfunction.

Display information

Item	specification
Display group	Assigns the channel for the group of trend and history.
Group	4
Assign to each group's channel number	≤ 4
Display color	RGB
Trend display	
Update rate	One note interval
Waveform line width	1 pixels
Display method	Display the right angel with time shaft(T) and measurement value(Y) Distribution: Horizontal、 Vertical Trend period: saving interval × 30 div
Scale	Display each channel scale(0%~100%)
Figure display	The measured value is displayed by number
Update rate	1 second
Bar display	The measured value is displayed in bar chart
Update rate	1 second
Scale	0% ~ 100%
History display	Display the saving data of EMS memory
Time shaft	Zoom in 1times/2 times /4 times /8 times /16 times /32 times
Display alarm summary	Most display 15 pieces alarm

Other display information

Item	Specification
Channel tag	10 characters (Numbers)
Channel units	7 characters (Numbers)
Status display	Display the instrument's status in top part of display screen.
Display content	Name, board card status, alarm status, USB status, circulation status, history status, year, month, day, hour, minute and second.
Auto-switch	Switch the display group in the appointed time interval Interval: 10 second
Language	English
System information display	Display the in-out、 relay output modes、 instrument additional function、 Firmware-Version and release date

18.3 Data Storage Specifications

Configure

Item	Specification
Onboard memory	Interior data storage
Medium	FLASH
Content	6MB
Operation	FIFO(first-in first-out)
Exterior storage	Backup interior memorized data
Medium	U disk
File format	FAT32
File name	DAT+“number”

Data type

Item	Specification
Data size	
Sampling	2 bytes/Data
Accumulation	4 bytes/Data
Data format	Binary system data
Sampling periods	Up to register interval
Note mode	Register all the time

18.4 Other standard functions

The correlative function of the time

Item	Specification
Clock	Runbetween 2000~2099
Clock precision	$\pm 10\text{ppm}$ (0 to 50°C), excluding a delay (of 1 second, maximum) caused each time the power is turned on.
Batteries Longevity	About 10years(room temperature)

The input character types

Item	Specification
Character	English(lowercase), English(capital), Numeral and symbol (limited)

18.5 Select fittings

Alarm output relay

Item	Specification
Motion	When alarm acts, output relay signal on the back panel's terminals.
Output ports	Maximum 12
Relay connect rating	250VAC(50/60Hz)/3A, 250VDC/0.1A(load resistance)
Output format	Normally open or close
Relay operation	OR operation

RS232C/RS485

Item	Specification
Confer	Modbus-RTU
Baud rate	1200/2400/4800/9600/19200/38400/57600 bps
Date length	8Bytes
Parity mode	None/odd/even

Ethernet

Item	Specifications
Interface	RJ45
Connection	10M
Protocols	Modbus-TCP

24VDC wiring

Item	Specification
Loop	4
Output voltage	22VDC ~ 25VDC(rating output current)
Maximum output current	65mADC(Over current protection operation current: approximately 90mADC)
Allow impedance	$\leq 750\Omega$

USB function

Parameter	Specification
USB port	Compatible USB2.0 composition
Ports	1
Capacity	Max: 32GB
Power supply	5V \pm 10%, 100mA
Attachable equipment	U Disk

Analog signals output

Parameter	Specification
Output type	4-20mA
Output channels	Most 4
Allowed impedance	$\leq 750\Omega$

18.6 General Specifications

Construction

Parameter	Specification
Mounting	Flush panel mounting(on a vertical plane)
Mounting Pitch	Mounting may be inclined backward up to 30 degrees from a horizontal plane.
Allowable Panel Thickness	2 to 26mm
Material	Front Panel & Rear Panel: ABS Case: Aluminum alloy
Dimensions	144(W)×144(H)×220(D) mm
Weight	Approx.4.0Kg(withoutOptional Accessories)

Standard operating conditions

Parameter	Specification
Power supply voltage	220VAC
Power supply frequency	50Hz
Ambient temperature	0°C~50°C
Ambient humidity	0% ~ 85%
Warm-up time	At least 30 minutes after power on
Installs position	Indoor

Power

Parameter	Specification
Rated power supply	220VAC
Allowable power supply voltage range	85VAC ~ 265VAC
Rated power supply frequency	50Hz~60Hz
Rated power consumption	≤59W(include option functions)

Insulation

Parameter	Specification
Dielectric strength	Between measuring input terminals:≥400V
Earth resistance	Earth resistance ≤ 10Ω

Transport and Storage conditions

Parameter	Specification
Ambient temperature	-10°C~60°C
Ambient humidity	0% ~ 95%

Standard Performance

Parameter	Specification
Measuring Accuracy	Standard operating conditions temperature: $23 \pm 2^\circ\text{C}$ humidity: $55\% \pm 10\% \text{RH}$ power supply voltage: 220VAC power supply frequency: $50\text{Hz} \pm 1\%$ warm-up temperature: at least 30 minutes after power on Other ambient conditions such as vibration should not adversely affect the operation. Measuring accuracy: Entire measuring range error $\leq 0.2\% \text{F.S.}$ Trend accuracy: $0.5\% \text{F.S.}$
Maximum allowable input voltage	-2VDC \sim +10VDC
Input resistance	Voltage signal: $\geq 1\text{M}\Omega$ Current signal: 250Ω
Resistance measure excitation current	0.5mA
Burnout measure current	About 2.5uA
Maximum common mode noise voltage	$\geq 300\text{VACrms}(50\text{Hz})$
Normal mode rejection	5VDC: 1VAC(50Hz) 100mV: 100mVAC(50Hz) 20mV: 50mVAC(50Hz)

Other standards

Parameter	Specification
Data storage age limit	About 10 years

18.7 Dimensional Drawings

Unit: mm

Dimension

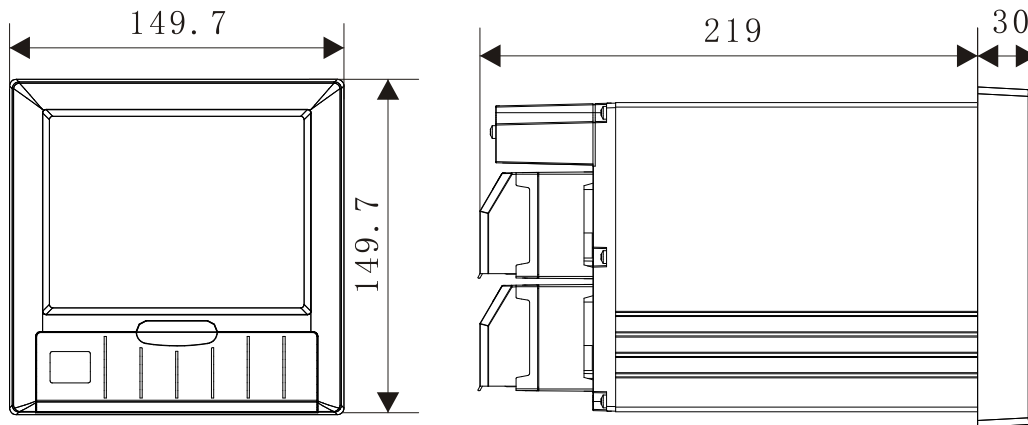

Panel Cutout

Single-Unit Mounting

