**User
Manual**

User's Manual

FOREWORD

Thank you for purchasing our flow meter!

This manual is about the functions, settings, wiring methods, methods of operation, failure of treatment methods of the flow meter. To ensure correct use, please read this manual carefully and use properly before operation and keep this manual in a safe place for quick reference.

Notice

- The contents of this manual are subject to change without prior notice as a result of continuing upgrades to the instrument's performance and functions.
- Every effort has been made in the preparation of this manual to ensure the accuracy of its contents. However, if you have any questions or find any errors, please feel free to contact us.
- Copying or reproducing all or any part of the contents of this manual without our permission is strictly prohibited.

Revisions

IML1XF-EZ01c

First Edition

Oct. 2021

CHECKING THE CONTENTS OF THE PACKAGE

Unpack the wrapping box and check the contents before operating the instrument. If some of the contents are not correct or missing or if there is any physical damage, contact our company or the sales network from which you purchased it.

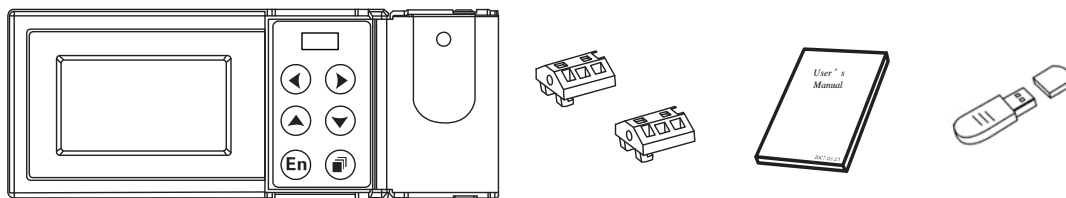

Instrument appearance

Mounting bracket

User's Manual

U disk

Accessories

Number	Name	Quantity	Notes
1	Mounting bracket	2	For panel mounting.
2	User's Manual	1	Order.
3	U disk	1	Order, Max: 32GB.

WARNING

- This instrument has many plastic parts, so use dry soft cloth in cleaning. Do not use benzene agents, banana water and other pharmaceutical agents in cleaning, which may cause discoloration or deformation.
- Do not put the charged products near the signal terminals, which may cause malfunction.
- Please do not have big impact on the instrument.
- If you confirm that the instrument has smoke, odor, noise, etc, please immediately cut off the power supply and promptly get in touch with the suppliers or company.

FOREWORD	I
CHECKING THE CONTENTS OF THE PACKAGE	II
CHAPTER 1 OVERVIEW OF THE INSTRUMENT	1
1.1 INTRODUCTION TO THE INSTRUMENT	1
1.2 INSTRUMENT STRUCTURE.....	3
1.3 INSTRUMENT INSTALLATION	4
1.4 INSTRUMENT WIRING	6
1.5 INSTRUMENT DISPLAY AND OPERATION	8
1.5.1 DIGITAL DISPLAY SCREEN OPERATION	9
1.5.2 SCREEN OPERATION OF INTERMEDIATE PARAMETERS	10
1.5.3 SCREEN OPERATION OF HISTORY TREND	10
1.5.4 FUNCTION SCREEN OPERATION	11
1.5.5 CONFIGURATION SCREEN OPERATION	11
1.5.6 EDITING OPERATION OF CONFIGURATION PARAMETER	13
CHAPTER 2 ANALOG SIGNAL INPUT	14
2.1 SIGNAL TYPE AND SPECIFICATION	14
2.2 SIGNAL DEBUGGING SCREEN	14
2.3 INPUT CONFIGURATION	15
2.3.1 SET THE BASIC PARAMETERS OF SIGNAL INPUT	16
2.3.2 SET SMALL SIGNAL CUTTING(REMOVAL).....	18
2.3.3 SET FILTER PARAMETER(FILTER)	18
2.3.4 SET LINEAR ADJUSTMENT (ADJUST K、 B)	18
2.3.5 SET DISCONNECTION COMPENSATION PARAMETER.....	18
2.3.6 MEASURING FREQUENCY CYCLE	18
CHAPTER 3 TEMPERATURE AND PRESSURE COMPENSATION AND FLOW ACCUMULATION	19
3.1 FLOW EXPRESSION OF COMMON FLOW SENSOR	20
3.2 PARAMETER CALULATION OF COMMON MATERIAL	22
3.3 CONVERSION OF VOLUME FLOW AND MASS FLOW	23
3.4 REYNOLDS NUMBER CALCULATION.....	23
3.5 DEVICE CONFIGURATION	24
3.5.1 SELECT THE MEASURING DEVICE	25
3.5.2 SET PARAMETER OF STANDARD ORIFICE /NOZZLE / VENTURI TUBE	26
3.5.3 SET V-CONE FLOWMETER PARAMETER	27
3.5.4 SET PARAMETER OF COMMON DIFFERENTIAL PRESSURE FLOWMETER	28
3.5.5 PULSE OUTPUT(FREQUENCY VORTEX) FLOWMETER.....	29
3.5.6 SET PARAMETER OF CURRENT OUTPUT FLOWMETER.....	30
3.5.7 ELBOW FLOWMETER.....	30
3.5.8 MASS FLOWMETER	30
3.6 MEDIUM CONFIGURATION.....	31
3.6.1 SELECT THE MEASURING MEDIUM	31
3.6.2 SATURATED STEAM MEDIUM CONFIGURATION	32
3.6.3 SUPERHEATED STEAM MEDIUM CONFIGURATION	32
3.6.4 WATER MEDIUM CONFIGURATION.....	33
3.6.5 GENERAL LIQUID MEDIUM CONFIGURATION	33
3.6.6 SINGLE GAS AND GENERAL GAS MEDIUM CONFIGURATION.....	34
3.6.7 MIXED GAS AND ARTIFICIAL GAS MEDIUM CONFIGURATION.....	35
3.7 FLOW CONFIGURATION	36

3.7.1 SET BASIC FLOW PARAMETERS	36
3.7.2 SET ADVANCED SETTLEMENT PARAMETER	37
3.7.3 SET STEAM STOP JUDGING PARAMETER.....	38
3.7.4 CLEAR FLOW TOTAL AMOUT.....	38
CHAPTER 4 HEAT FUNCTION	39
4.1 INTRODUCTION TO HEAT FUNCTION	39
4.2 HEAT CONFIGURATION	39
4.3 CLEAR HEAT TOTAL AMOUNT	40
CHAPTER 5 RS485 COMMUNICATION	41
5.1 REGISTER ADDRESS LIST	41
5.2 CONNECTION MODE.....	42
5.3 COMMUNICATION CONFIGURATION.....	43
CHAPTER 6 ANALOG TRANSMITTER OUTPUT	44
6.1 TRANSMITTER OUTPUT SPECIFICATION	44
6.2 OUTPUT CONFIGURATION.....	44
CHAPTER 7 CHANNEL ALARM	45
7.1 ALARM AND CONFIGURATION.....	45
7.2 ALARM LIST SCREEN	46
7.3 CLEAR ALARM LIST	46
CHAPTER 8 HISTORY DATA	47
8.1 RECORDING FUNCTION AND CONFIGURATION.....	47
8.2 HISTORY DATA QUERY SCREEN	48
8.3 CLEAR HISTORY RECORD.....	48
CHAPTER 9 ACCUMULATIVE REPORT	49
9.1 ACCUMULATIVE REPORT FUNCTION AND CONFIGURATION.....	49
9.2 ACCUMULATIVE REPORT QUERY SCREEN	50
9.2.1 YEARLY REPORT SCREEN.....	50
9.2.2 MONTHLY REPORT SCREEN	51
9.2.3 SHIFT REPORT SCREEN	51
9.3 CLEAR ACCUMULATIVE REPORT	51
CHAPTER 10 POWER-DOWN RECORD.....	52
10.1 POWER-DOWN RECORD FUNCTION.....	52
10.2 POWER-DOWN RECORD QUERY SCREEN	52
10.3 CLEAR POWER-DOWN RECORD.....	52
CHAPTER 11 SYSTEM LOG.....	53
11.1 SYSTEM LOG FUNCTION.....	53
11.2 SYSTEM LOG QUERY SCREEN.....	53
CHAPTER 12 DOUBLE PASSWORD PROTECTION	54
12.1 DOUBLE PASSWORD PROTECTION FUNCTION	54
12.2 PASSWORD SETTING SCREEN.....	54
CHAPTER 13 SYSTEM CONFIGURATION	55
13.1 DATE AND TIME.....	55
13.2 INSTRUMENT NUMBER.....	55
13.3 RESTORE FACTORY SETTING.....	56
CHAPTER 14 USB DATA BACKUP.....	58
14.1 DATA BACKUP FUNCTION.....	58
14.2 DATA BACKUP SCREEN	58
CHAPTER 15 CONFIGURATION BACKUP	59
15.1 CONFIGURATION BACKUP FUNCTION	59
15.2 CONFIGURATION BACKUP SCREEN	59

CHAPTER 16 SPECIFICATION.....	60
16.1 SIGNAL,DISTRIBUTION AND ALARM.....	60
16.2 DISPLAY SPECIFICATION	60
16.3 GENERAL SPECIFICATION	61
APPENDIX 1 COMMON GAS DENSITY IN STANDARD CONDITION.....	63
APPENDIX 2 EXAMPLES OF STANDARD ORIFICE CONFIGURATION	64
APPENDIX 3 EXAMPLE OF FREQUENCY VORTEX CONFIGURATION	66

CHAPTER 1 OVERVIEW OF THE INSTRUMENT

1.1 INTRODUCTION TO THE INSTRUMENT

In accordance with the relevant international standards, national and industry standards, this instrument has established a variety of flow mathematical models for different flow sensors and media in order to have accurate flow measurement and calculation. It can be widely used in the trade settlement and calculating management network of petrochemical, chemical, metallurgy, electric power, light industry, medicine, city gas, heating and other industries.

Scope of usage

- Suitable medium: gas, superheated steam, saturated steam, general gas, mixed gas, water, hot water, liquid (oil, chemical products), etc.
- Flow sensors: throttle flowmeters (all types of orifice plates, ISA1932 nozzle, long-diameter nozzle, venturi nozzle, and classic venturi tube), V-cone flowmeter, elbow flowmeter, vortex flowmeter, turbine flowmeter, electromagnetic flowmeters, mass flowmeters, etc.

Compensation calculation

- Conduct real-time calculation on the discharge coefficient C , compression factor Z , and expansion rate of flow rate ϵ in throttle flowmeter according to GB/T2624-2006 (ISO 5167-2003) .
- The calculation of vapor density is based on IAPWS-IF97 formula.

Calculating Management

- Automatic conversion of flow units, and setting of the segmented flow coefficient.
- Debugging calculus function: support to view the original value of analog signal; support to view various intermediate parameters in flow calculation, such as density ρ , the Reynolds number Re_d , discharge coefficient C compression factor Z , expansion coefficient ϵ , dynamic viscosity μ , isentropic index κ and other data.
- Trade settlement: small signal cut, blackout complement, small flow complement, overrun compensation measurement and other useful features.
- Audit record: blackout recording and logging operation function.
- Historical data: record the amount of flow, temperature, pressure, differential pressure (frequency) and the total instantaneous amount.
- Alarm list: record differential pressure (frequency), temperature, pressure and other instantaneous alarm information.

- Accumulative report: support the accumulative flow, heating monthly report and annual report.
- Fault tolerance function: if there is any temperature, pressure signal abnormalities, use emergency parameter value to conduct compensate operation.
- Communication function: standard Modbus RTU protocol, RS-485 communication interface.
- Transfer storage function: Use USB interface to have transfer storage of internal data in the instrument.

1.2 INSTRUMENT STRUCTURE

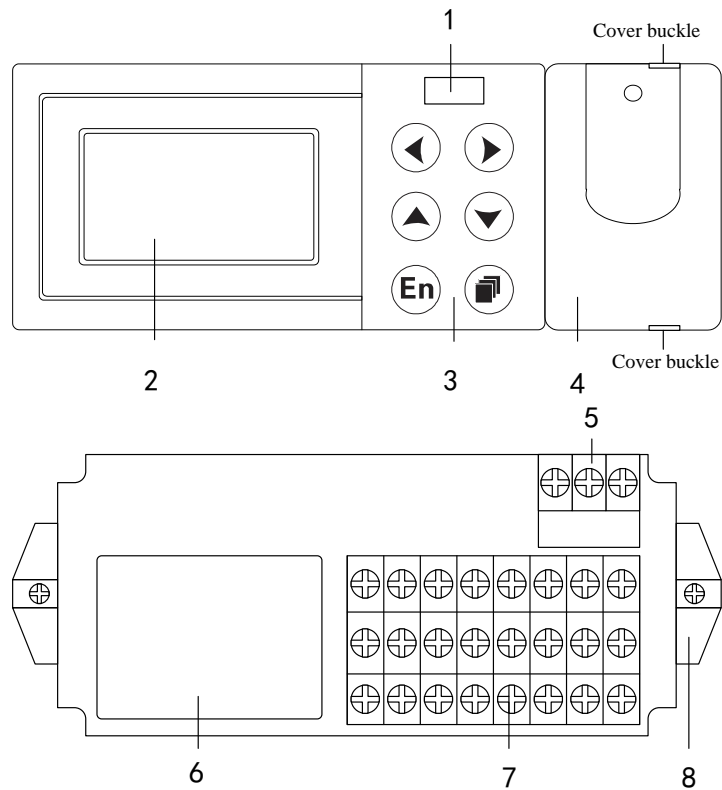

1. USB storage interface: store historical data, reports, power-down record and other data in the instrument.
2. LCD digital screen: display digital display screen, intermediate parameters, and historical curve.
3. Keyboard: left, right, increase, reduce, enter, page.
4. Operation cover: protect the USB interface and keyboard by using the cover buckle to open operation cover.
5. Power terminal: Connect the power line and grounding protection line.
6. Terminal wiring diagram: signal wiring.
7. Signal terminals: connect the input and output signals.
8. mounting bracket: fix instrument in panel mounting.

1.3 INSTRUMENT INSTALLATION

Describe the installation site and installation method. Be sure to read this section before installation

Notes:

- The instrument is panel mounting type.
- Please install it indoors to keep away from rain and direct sunlight
- In order to prevent the increase in the internal temperature of the instrument, please install it in a well-ventilated place.
- Do not tilt while installing the instrument, and try to have level installation (backward <math><30^\circ</math>).

Avoid the following places in installation:

- Near the place where there is direct sunlight and heat appliances.
- The working place in which temperature exceeds 50°C
- The working place in which environment humidity exceeds 85%.
- Places near the occurrence of electromagnetic source
- Mechanical vibration strong places.
- Place where temperature changes quickly and it is easy to dew.
- Places where there are much fume, steam, moisture, dust and corrosive gas.

Installation method

Please use 2 ~ 12 mm steel plates for the instrument panel.

1. Put the instrument in the front of the panel.
2. Use the mounting brackets of instrument to install as shown below:
 - Use mounting brackets to fix on the both sides of the instrument
 - The screws used in mounting bracket of panel are M4 standard screws.

Installation diagram

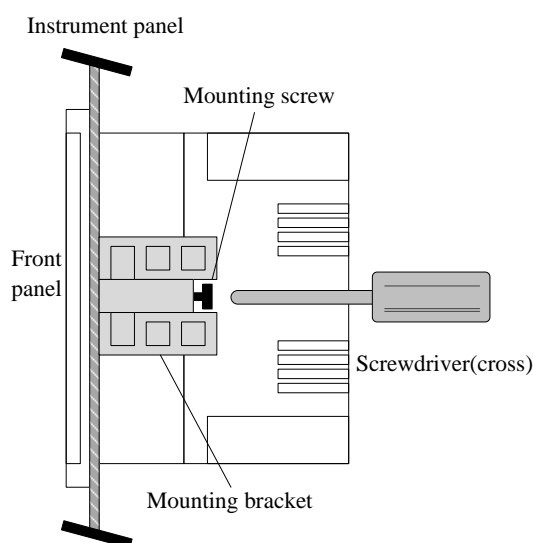

External dimensions

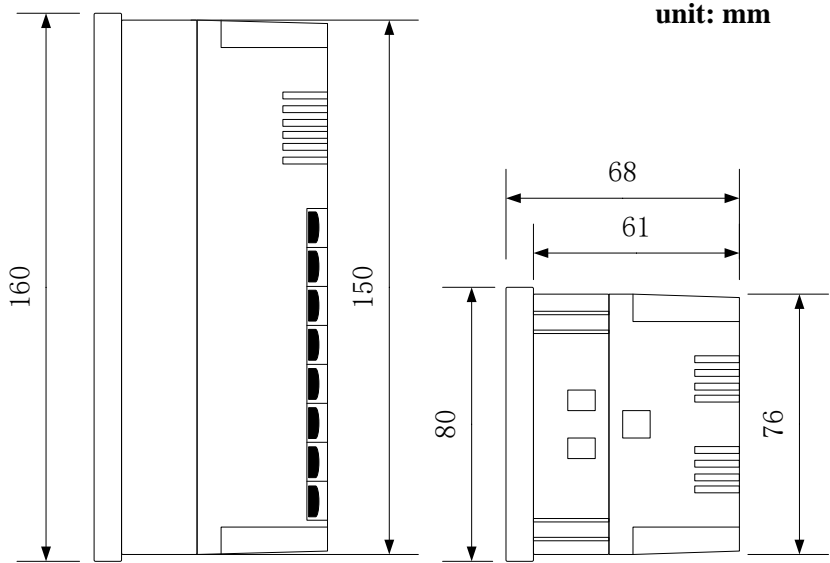

Instrument installation dimensions

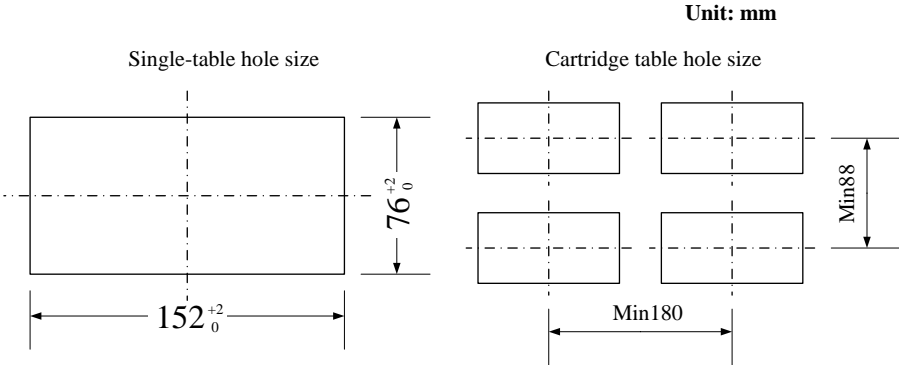

1.4 INSTRUMENT WIRING

Wiring method

1. Before wiring, please disconnect the power to the instrument.
2. the input / output signal line and the input / output terminal is connected.
3. In order to prevent poor contact, carefully tighten the screws after the wiring.
4. It is recommended to use the pressure line terminals with insulation sleeve (4mm screws are used).

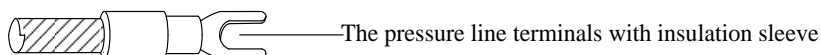

The pressure line terminals with insulation sleeve

Please observe the following warning in the power wiring, or it may cause electric shock or damage to the instrument.

NOTE

- To prevent electric shock, make sure that the instrument is not powered.
 - To prevent fire, please use double insulated wire.
 - Use terminals with insulated sleeve for power wiring and protective ground (4mm screws are used).
 - Set air switch in the 220VAC/24VDC power circuit, and set the instrument separated from the total power.
Air switch specifications: current rating :> 3A
 - Please connect 2A ~ 15A fuse in the 220VAC power supply circuit.
 - Please connect the 1A fuse in the 24VDC power supply circuit.
-

Power specification

Item	Content
Input voltage	85VAC ~ 265VAC orDC~26VDC
Input frequency	50Hz

Please note to prevent interference from entering the measurement circuit

- Please separate measuring circuit from power circuit or ground circuit.
- It would be better for the measurement object not to be the interfering source. Once it can not be avoided, please set insulation between measurement object and measuring circuit, and ground the measuring sensor.
- For the electrostatic induction interference, it is advisable to use shielded wires.
- For the interference produced by electromagnetic induction, it is better to intensively connect the measurement circuit wiring at the equal distance.
- If the input wiring is in parallel connection with other instrumentation, it will affect the measured values.

NOTE

The input signal should not exceed the following value; otherwise it will damage the instrument.

Current : -4mA ~ +25mA

The largest common mode interference voltage: 250VACrms (50Hz)

Terminals and wiring diagram

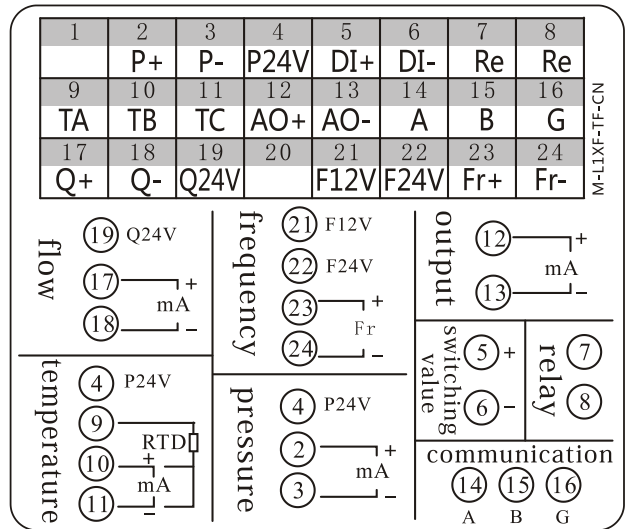

1.5 INSTRUMENT DISPLAY AND OPERATION

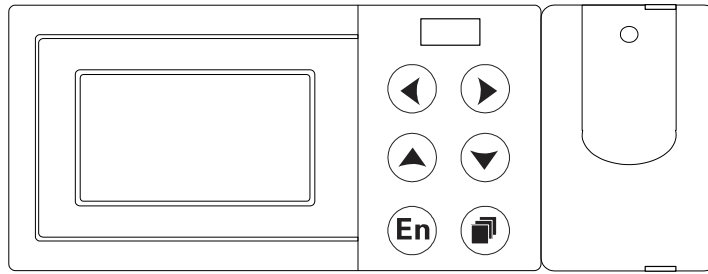

Screen display

The instrument is equipped with a monochrome dot-matrix liquid crystal display device.

Use [page] key to have circular switching of the screen, use [left] + [page] key to enter the configuration.

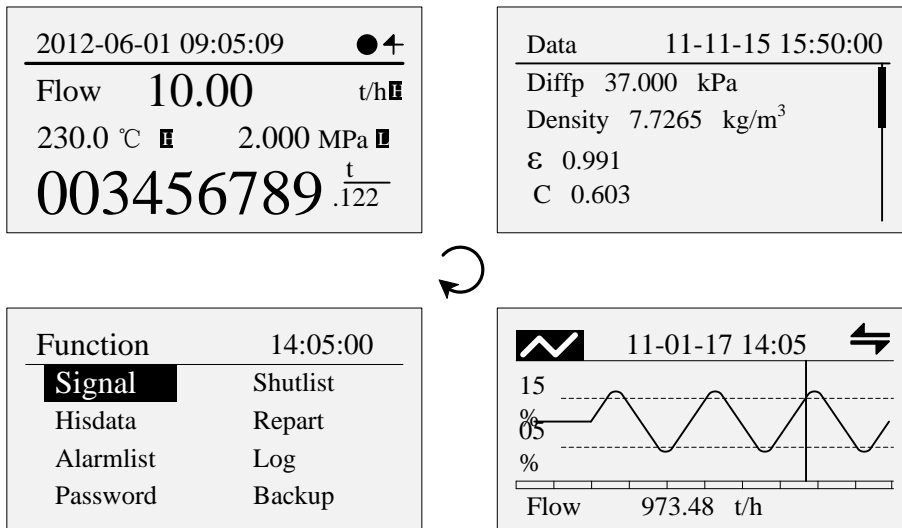

Key Description

- : Left key to move the cursor forward.
- : Right key to move the cursor backward.
- : Increase key to increase the value of the cursor data
- : Reduce key to reduce the value of the cursor data.
- : Enter key to perform the function of the cursor or edit the cursor data.
- : Page key to have circular switching of the running screen.
- + : Configuration composite key, pressing them at the same time to enter the configuration screen

1.5.1 DIGITAL DISPLAY SCREEN OPERATION

Start-up screen, use [page] key to have circular switching to this screen

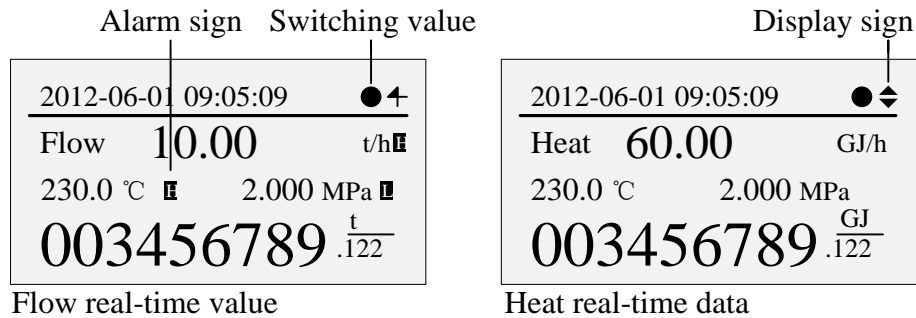

Real-time data

Simultaneously display flow, temperature, pressure, the total amount of the flow as well as heat, temperature, pressure, and the total amount of heat (when heat function is started).

The maximum of total amount is 999,999,999. It will be displayed as fixed three decimal, and it will return to zero after overflow.

The maximum of flow is 500000, and display accuracy is determined according to decimal numbers of the range.

Alarm sign

When the alarm channel exists, HL alarm sign is displayed after the channel name.

Display sign

Automatic display flow and heat data. Automatic display function will be unavailable when the heat function is turned off. The interval of automatic display can be set in the configuration of the screen.

Automatic display status sign , use the [Enter] key to switch automatic \ manual display function.

Manual display status sign , use the [increase] [reduce] key to read the real-time data manually.

Screen Configuration

Configuration location: Configuration -> function configuration -> screen configuration screen is as follows:

Display config

Interval 20s

Exit

The display interval: 5 seconds / 10 seconds / 20 seconds / 30 seconds / 1 minute (optional) . The factory default is 10 seconds.

1.5.2 SCREEN OPERATION OF INTERMEDIATE PARAMETERS

Use [Page] keys to have circular switching to this screen.

Display compensation intermediate parameter related to measuring device and measuring media.

A001	11-11-15 15:50:00
Diffp	37.000 kPa
Density	7.7265 kg/m ³
ε	0.991
C	0.603

Use [Increase] [Decrease] key to view the data.

1.5.3 SCREEN OPERATION OF HISTORY TREND

Use [page] key to have circular switching to the screen.

Please refer to Chapter 8 for viewing history data

Historical curve supports channel: flow, heat, temperature, pressure, differential pressure.

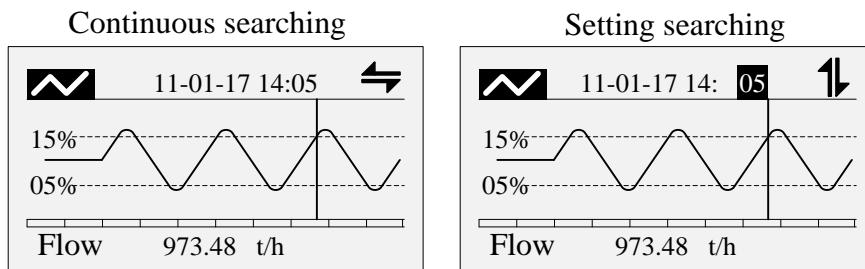

Channel switching

Use [Increase] [Reduce] to switch channel: flow, heat, temperature, pressure, differential pressure.

Continuous searching

Use [Left] [Right] key to view history trend by continuously adjusting searching time.

Fixed-point searching

Use [Enter] key to enter the fixed-point searching mode, and the time is editable.

Use [Increase] [reduce] key to modify time, and press [Enter] key to view the historical data.

It will be automatically switched to the continuous searching mode.

1.5.4 FUNCTION SCREEN OPERATION

Use [Page] key to switch to the screen. This screen provides the entrance of signal debugging, blackout records, historical data, accumulative reports, alarm list, operating log, password revise, data backup these eight function screens.

Function	14:05:00
Signal	Shutlist
Hisdata	Repart
Alarmlist	Log
Password	Backup

Use [Left] [Right] key to move the cursor.

Use [Enter] key to enter the corresponding sub-function screen.

Use [Page] key to exit the current sub-function screen.

1.5.5 CONFIGURATION SCREEN OPERATION

- **Enter the configuration screen**

Press [Left] + [page] key simultaneously to enter configuration entrance screen.

Password for supplier	
000000	😊
L1XF1000	Exit

Password for user	
000000	😊
L1XF1000	Exit

Use [left] [right] key to move the cursor.

Use [increase] [reduce] keys to enter the password.

When the cursor is located at the **Password**, use **【Enter】** to confirm the password input.

When the cursor is located at the **Exit**, use **【Enter】** to exit the configuration screen.

Note

The instrument provides a dual password protection. only when the demand-side password and supply-side password are all correct can the configuration screen be entered. The initial password is 000000.

- **Select configuration entrance**

After the password is entered correctly, display classified entrance of configuration.

Config		Function		
Flowmeter	Medium	System	Alarm	Output
Input	Flow	Con	View	Report
Heat	Function	Confif	About	
	Exit			Exit

Use [Left] [Right] keys to move the cursor to select the configuration entrance
Use the [Enter] key to enter the corresponding configuration screen

- **Confirm modification operation**

While executing unrecoverable operation, it will pop up a dialog box to confirm the operation in order to reduce wrong operation.

It will mainly include the following operation: restore factory settings, clear power-down record, clear accumulative report, clear the alarm list, clear the logging record, clear total amount of flow, Clear total amount of heat, etc.

Factory setting?

Select **Yes**, perform this operation function.

Select **No**, do not perform the operation.

- **Save configuration modification**

After parameter modification is completed, select **Exit** to pop up the dialog box for confirming to save.

Save Config?

Select **Yes**, save the setting content and exit the configuration screen.

Select **No**, do not save the setting content and exit the configuration screen.

Select **Cancel** to return to the configuration screen, and continue to set the parameters.

1.5.6 EDITING OPERATION OF CONFIGURATION PARAMETER

Configuration parameters are divided into two editing types, namely, **【Parameter selection】** and **【Numeric edit】**.

- **Parameter selection**

Use **【Increase】** and **【Reduce】** key to select the parameter content in which the cursor is, or to fine-tune the value.

- **Numeric edit**

When the input value is large, it will be input through the input panel.

Move the cursor to the item of editing parameter, use **【Enter】** to pop up input panel for input operation.

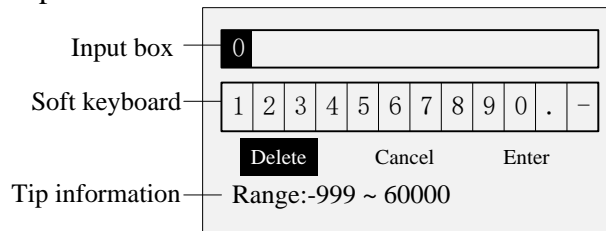

Use **【Left】** **【Right】** key to move the cursor of the soft keyboard.

Use **【Enter】** key to select value where the cursor is to the input box.

【Delete】 function: Delete the last character of the input box.

【Cancel】 function: Cancel editing, exit the Input Panel.

【Enter】 function: confirm editing and exit the input panel.

Note

When the input value is over the range, it will not be able to confirm.

Then, the correct range of input value will be black and reminds the user to check the input value

CHAPTER 2 ANALOG SIGNAL INPUT

2.1 SIGNAL TYPE AND SPECIFICATION

The instrument is 3-channel input, and the instrument measurement period is one second. It has small signal cutting, inertial filter function, and it supports even breakout processing as well as the following signal types

Channel	Input method	Input type	Measuring range
Flow	DC current	4~20mA	4.00mA ~ 20.00mA
	frequency	0.0~10000.0Hz	0.0 ~ 10000.0Hz
Temperature	Thermal resistance	PT100	-50.0°C ~ 650.0°C
		PT1000	-50.0°C ~ 250.0°C
	DC current	4~20mA	4.00mA ~ 20.00mA
Pressure	DC current	4~20mA	4.00mA ~ 20.00mA

As for the connection mode, please refer to [1.4 instrument wiring].

2.2 SIGNAL DEBUGGING SCREEN

Screen location: Function screen -> signal debugging to display the original data of the analog signal.

e.g. The differential pressure (frequency), the temperature and pressure value

Signal		
Diffp	8.200	mA
T	220.00	Ω
P	12.400	mA

Operation

Use **【Page】** key to exit the screen

2.3 INPUT CONFIGURATION

Set the relevant parameters of the analog signal, including the differential pressure (volume, frequency, and flow rate), temperature, pressure channel settings.

Location configuration: Configuration -> input configuration. The configuration screen is as follows (expanded diagram)

Input	
Chnl	Diffp
Mode	Input
Type	4-20mA
Unit	MPa
Scale	0.00 ~ 1.60
Cut	0.0%
Filter	0.0秒
K	1.00
B	0.00

Exit

Input	
Chnl	Fr
Mode	Input
Type	Fr
Unit	Hz
Scale	0 ~ 5000
Cut	30Hz
50HzFilter	10s
K	1.00
B	0.00
Cvcle	10s

Exit

Input	
Chnl	Diffp
Mode	Set
Settings	10.00
Unit	kPa

Exit

Input	
Chnl	P
Mode	Calculation

Exit

2.3.1 SET THE BASIC PARAMETERS OF SIGNAL INPUT

Channel

Signal input channel. According to the different measuring devices, there will be different channel combinations.

The corresponding relationship between channel and the measuring devices is shown in the following table:

Measuring device	Signal channel
Standard orifice	Differential pressure, Temperature, Pressure
Standard nozzle	
Standard venturi tube	
V-cone flowmeter	
General differential pressure flowmeter	
Elbow flowmeter	
Pulse output flowmeter	Frequency, Temperature, Pressure
Current output flow meter	Volume, Temperature, Pressure
Mass flowmeter	Flow, Temperature, Pressure

Mode

Channel input mode is divided into 3 types: input, set and calculation.

- Input: external signal connection.
- Setting: Set the fixed value of channel.
- Calculation: When selecting the saturated steam temperature compensation, pressure can choose calculation;
When selecting the saturated steam pressure compensation, temperature can select calculation.

Type

Channel signal types. Different channels have different signal types.

- Differential pressure signal: DC current.
- Frequency signal: frequency.
- Temperature signal: RTD, DC current.
- Pressure signal: DC current.

The measuring range of the signal type is shown in the following table:

Signal	Type	Measuring range
DC current	4-20mA	4.00mA ~ 20.00mA
frequency	FR	0.0Hz ~ 10000.0Hz
Thermal resistance	PT100	-50.0°C ~ 650.0°C
	PT1000	-50.0°C ~ 250.0°C

Unit

Set the channel units to participate in the compensation calculation. Group of units for each channel are as follows:

Differential pressure: Pa, kPa

Frequency: Hz

Volume: L / h, m³/h、 km³/h

Flow: use flow units, channel units are not available, kg / h, L / min, t / h, m³/h、 km³/h

Temperature: °C

Pressure: kPa, Mpa

Range

Set the high and low range limit of input signal.

2.3.2 SET SMALL SIGNAL CUTTING(REMOVAL)

When the input signal is less than the value, perform the resection function to display the low limit range.

When the input signal is a normal signal, the value is range percentage.

When the input signal is a frequency signal, the value is the actual frequency value.

It is valid only for the flow channel.

2.3.3 SET FILTER PARAMETER(FILTER)

Set filter time constant, the range is from 0.0 second to 9.9 seconds.

Filter calculation method:

display value= previous measuring value *filter time constant+ current measuring value / filter time constant +1

When the signal is frequency, the parameter is a 50Hz signal filter time parameter (0 to 10 seconds).

If the frequency is continuously $50 \pm 0.3\text{Hz}$ within the time of the filtering, it needs to do filtering removal.

2.3.4 SET LINEAR ADJUSTMENT (ADJUST K、 B)

When there are errors in the input signal value , it can be fine tuned.

Adjustment formula: actual value = measured value \times K + B.

2.3.5 SET DISCONNECTION COMPENSATION PARAMETER

When signal disconnection is detected, use this parameter as the channel values to be involved in the compensation calculation. The flow channel has no such parameter.

2.3.6 MEASURING FREQUENCY CYCLE

It is valid only for the frequency channel, and it will use the average value for the measuring frequency per second in this cycle. A group can be from 1 to 10 seconds.

CHAPTER 3 TEMPERATURE AND PRESSURE COMPENSATION AND FLOW ACCUMULATION

This instrument has a strong function of temperature and pressure compensation.

According to the the setting measuring device and measuring medium parameters, it will conduct real-time compensation calculation of instantaneous flow and accumulative total amount . It supports 9 categories of measuring device and 8 categories of measuring media.

Throttle flow meter standard GB/T2624-2006 (ISO 5167-2003).

The calculation of vapor density is based on IAPWS-IF97 formula.

Instrument support 9 broad categories of measuring devices:

1. Standard orifice plate
2. Standard nozzle
3. Standard venturi tube
4. V cone flowmeter
5. Common differential pressure flowmeter
6. Elbow flowmeter
7. Pulse output flowmeter
8. Current output flowmeter
9. Mass flowmeter

Instrument supports 8 categories of measuring medium:

1. Saturated steam (support temperature compensation, pressure compensation)
2. Superheated steam
3. Water
4. General liquids
5. Single gas (support 18 kinds of standard gas: air Air, nitrogen N₂, oxygen O₂, helium He, hydrogen H₂, argon Ar, CO, carbon dioxide CO₂ , hydrogen sulfide H₂S , ammonia NH₃, methane CH₄, ethane C₂H₆, propane C₃H₈ and butane C₄H₁₀, ethylene C₂H₄, acetylene C₂H₂., propylene C₃H₆, butene C₄H₈)
6. General gas
7. Mixed gas
8. Artificial gas

3.1 FLOW EXPRESSION OF COMMON FLOW SENSOR

- **Mass flow expression of standard throttling device:**

$$q_m = \frac{C}{\sqrt{1-\beta^4}} \varepsilon \frac{\pi}{4} d^2 \sqrt{2\Delta_p \times \rho} \times 3600 \quad \dots\dots\dots (1)$$

Formula (1):: q_m ——mass flow, kg/h;

C ——Discharge coefficient (dimensionless);

ε ——The expansion coefficient of flow rate(dimensionless);

d ——The opening diameter of the orifice, m

Δ_p ——Differential pressure, Pa;

ρ ——The gas density in the work state, kg/m³;

β ——Diameter ratio (dimensionless).

Dis calculated as follows in the formula (1):

$$d = d_{20} [1 + \alpha_d (t - 20)] \quad \dots\dots\dots (2)$$

In the formula (2): d_{20} ——20℃ orifice opening diameter, m;

α_d ——expansion coefficient of orifice line, 1/℃。

Formula (1), the calculation of ε , C is in accordance with GB2624-2006 "use the flow of orifice plate, nozzle and venturi tube to fill the fluid flow of tube" or ISO5167: 2003 (E) “measue flow with the differential pressure device in a flow-filled round cross section tube”.

- **vortex flow (or turbo) flow sensor with temperature and pressure compensation**

Mass flow expression of measuring gas (hydrocarbons) :

$$q_m = 3.6 \times \frac{F}{K} \times \rho_N \times \frac{P \times T_N \times Z_N}{P_N \times T \times Z} \quad \dots\dots\dots (3)$$

Formula (3): q_m ——mass flow, kg/h;

F ——the pulse signal frequency from the vortex (or turbine) flowmeter, Hz;

K ——average instrument factor of vortex (or turbine) flowmeter, 1/L;

P ——The pressure of working conditions;

ρ_N ——gas density under standard condition, kg/ m³;

P_N — Standard atmospheric pressure, Pa;

Z_N — Gas compression coefficient (dimensionless) under the standard condition;

Z — Gas compression factor (dimensionless) in the working condition;

T_N — gas temperature under the standard condition, K;

T — gas temperature under the working condition, K.

In Formula (3), the Z value is calculated on the basis of formula (7).

● **Turbine flow meter with temperature compensation for measuring liquids (gasoline or diesel)**

Mass flow expression:

$$q_m = 3.6 \times \frac{F}{K} \rho_{20} [1 - \lambda(t - 20)] \dots\dots\dots (4)$$

Formula (4): q_m — mass flow, kg/h;

λ — volume temperature coefficient, $1/^\circ\text{C}$;

K — average instrument coefficient of turbine flowmeter, 1/L;

F — pulse signal frequency from the turbine flowmeter, Hz;

ρ_{20} — density of liquids(oil) 20°C

● **Vortex flowmeter with pressure(or temperature) or pressure and temperature**

Flow expressions of measuring saturated or superheated steam mass:

$$q_m = 3.6 \times \frac{F}{K} \rho \dots\dots\dots (5)$$

The formula (5): q_m — mass flow, kg/h;

K — average instrument coefficient of vortex flowmeter, 1/L;

F — pulse signal frequency from vortex flowmeter, Hz;

ρ — steam density in working condition, kg/m^3 ;

3.2 PARAMETER CALCULATION OF COMMON MATERIAL

- **Density calculation of non-hydrocarbon dry gas:**

$$\rho = \rho_N \times \frac{P \times T_N \times Z_N}{P_N \times T \times Z} \dots\dots\dots (6)$$

In the formula (6), The compression coefficient Z is based on the following formula:

Use Redlich-Kwong equation, or simply RK formula to solve the question.

$$Z^3 - Z^2 - (B^2 + B - A)Z - AB = 0 \dots\dots\dots (7)$$

In formula (7): $A = \frac{0.42748P_r}{T_r^{2.5}} ;$

$$B = \frac{0.086647P_r}{T_r} ;$$

$$T_r = \frac{T}{T_c}$$

$$P_r = \frac{P}{P_c}$$

Tc,Tp: The critical temperature and critical pressure of the gas

- **Vapor density calculation:**

The vapor density calculation is based on IAPWS-IF97 formula.

3.3 CONVERSION OF VOLUME FLOW AND MASS FLOW

Mass flow expression:

$$q_m = q_V \rho \dots\dots\dots (8)$$

Expression of volumetric flow under the working conditions:

$$q_V = \frac{q_m}{\rho} \dots\dots\dots (9)$$

Standard volumetric flow expressions:

$$q_{VN} = \frac{q_m}{\rho_N} \dots\dots\dots (10)$$

Formula (10):: q_m ——mass flow, kg/h

q_V ——The volume flow under the working conditions, m³/h;

q_{VN} ——volumetric flow under standard condition, N m³/h;

ρ ——gas density in the working condition, kg/m³;

ρ_N ——gas density in the standard condition, kg/m³。

Standard condition is at 20 °C, 0.101325Mpa

3.4 REYNOLDS NUMBER CALCULATION

$$Re_D = \frac{4q_m}{3600\pi\mu D} \dots\dots\dots (11)$$

Formula (11): μ ——medium dynamic viscosity, Pa·S;

D ——diameter of the pipe, m

3.5 DEVICE CONFIGURATION

Device configuration includes the type of device and its pipeline materials, cutting pieces material, pipe diameter, cutting pieces caliber and other parameters.

Instrument supports the following 17 kinds of pipe material and cutting pieces material:

1. 15 steel, A3 steel
2. A3F, B3 steel
3. 10 Steel
4. 20 Steel
5. 45 Steel
6. 1Cr13
7. Cr17
8. 12Cr1Mov
9. 10CrMo910
10. Cr6SiMo
11. X20CrMoWV
12. 1Cr18Ni9Ti
13. Ordinary carbon steel
14. Industrial copper
15. Copper
16. Brass
17. Gray cast iron

3.5.1 SELECT THE MEASURING DEVICE

Location of configuration: Configuration -> Device Configuration, configuration screen is as follows:

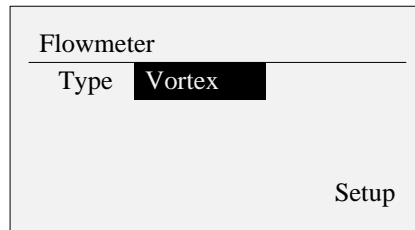

Type

Device type has secondary classification, and the classification table is as follows:

First classification	Secondary classification
Standard orifice	Flange pressure orifice plate
	Corner pressure orifice plate
	D and D/2 pressure orifice plate
Standard nozzle	ISA1932 nozzle
	Diameter nozzle
	Venturi nozzle
Standard venturi tube	Casting shrinkage segment
	Machining contraction section
	Rough welding sizzling contraction section
V-cone flowmeter	None
General differential pressure flowmeter	None
Pulse output flowmeter	Frequency vortex
Current output flowmeter	4-20mA type vortex
	Electromagnetic flowmeter
	Linear flowmeter
Elbow flowmeter	None
Mass flowmeter	None

After setting the first classification of the device type, enter the parameter setting device and set the secondary classification device and its detailed parameters.

Note

After changing device type, it needs to complete parameter settings so as to exit configuration.

3.5.2 SET PARAMETER OF STANDARD ORIFICE /NOZZLE / VENTURI TUBE

Set the related parameters of standard orifice, standard nozzles, and standard venturi tube measuring devices.

Configuration interface (expanded view) is as follows:

Setup		
Type	Flange orifice	
Sqrt	Yes	
Tube	20#	
Throttle	1Cr18Ni9Ti	
D20	500	mm
d20	400	mm
Exit		

Device

Measuring device can choose the following:

Standard Orifice: Flange pressure orifice, corner pressure orifice, D and D / 2 pressure orifice.

Standard nozzle: ISA1932 nozzle, diameter nozzle, venturi nozzle.

Standard venturi tube: casting shrinkage segment, machining contraction segment, rough welding iron contraction segment.

Square root

When the flow signal is the differential pressure signal, set the square root types of differential pressure signal which is output by the differential pressure transmitter.

- Sqrt of this instrument: when differential pressure transmitter has no sqrt and it is required to have the square root of the differential pressure signal during compensation, select this setting.
- Differential change sqrt: when the differential pressure signal of pressure transmitter has sqrt, select this setting.

Pipe material

The material used for the manufacturing of pipes. Different manufacturing materials have different coefficient of linear expansion λd .

Orifice plate material

The material used for manufacturing throttles. different manufacturing materials have different coefficient of linear expansion λd .

Pipe diameter

Diameter of the pipe at 20 °C.

Orifice plate diameter

Diameter of throttle at 20 °C.

3.5.3 SET V-CONE FLOWMETER PARAMETER

Set related parameters of V cone flowmeter measuring device. Configuration interface (expanded view) is as follows:

Setup	
Sqrt	Yes
C	0.00
ϵ	0.00
Tube	20#
Throttle	1Cr18Ni9Ti
D20	500 mm
d20	400 mm

Exit

Square root

When the flow signal is the differential pressure signal, set the square root types of differential pressure signal which is output by the differential pressure transmitter.

- Sqrt of this instrument: when differential pressure transmitter has no sqrt and it is required to have the square root of the differential pressure signal during compensation, select this setting.
- Differential change sqrt: when the differential pressure signal of pressure transmitter has sqrt, select this setting.

Discharge coefficient

V-cone device designs discharge coefficient (according to the design of the book).

Coefficient of expansion

V-cone device designs expansion coefficient (according to the design of the book).

Pipe material

The material used for the manufacturing of pipes. Different manufacturing materials have different coefficients of linear expansion λd .

Cone Material

The material used for the manufacturing of the cone. Different manufacturing materials have different coefficients of linear expansion λd .

Pipe diameter

Diameter of the pipe at 20 °C.

V cone diameter

V cone diameter at 20 °C.

3.5.4 SET PARAMETER OF COMMON DIFFERENTIAL PRESSURE FLOWMETER

Generic differential pressure flow parameters set

Set parameters for measuring devices of differential pressure flowmeters.

Configuration interface (expanded view) is as follows:

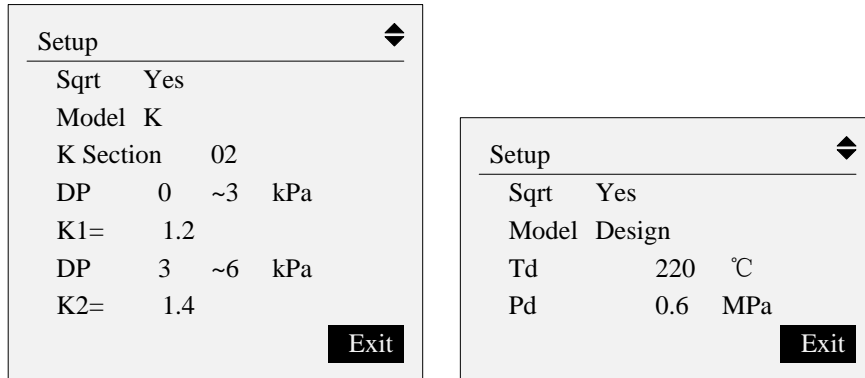

Square root

When the flow signal is the differential pressure signal, set the square root types of differential pressure signal which is output by the differential pressure transmitter.

- Sqrt of this instrument: when differential pressure transmitter has no sqrt and it is required to have the square root of the differential pressure signal during compensation, select this setting.
- Differential change sqrt: when the differential pressure signal of pressure transmitter has sqrt, select this setting.

Model

Set computing model, optional: K factor and design parameters.

Select **【K factor】** model

K factor segments

The number of K factor segment. One group is up to 10 segments.

K factor

Based on the flow formula $Q = k\sqrt{\Delta P \cdot \rho}$, set differential pressure segment

K factor.

Q unit: kg/h, ΔP unit: Pa, ρ is kg/m³

Select **【design parameter】** model

Design temperature, design pressure

$$Q = Q_{\max} \sqrt{\frac{\Delta P}{\Delta P_{\max}} \times \frac{\rho}{\rho_d}}$$

According to the flow formula temperature and design pressure.

3.5.5 PULSE OUTPUT(FREQUENCY VORTEX) FLOWMETER

Set related parameters of pulse output type (frequency type vortex) flowmeter measuring device.

Configuration interface (expanded view) is as follows:

Setup	
Type	Vortex
K Section	02
K Unit	1/m ³
Fr	0 ~500 Hz
K1=	1.2
Fr	500 ~1000 Hz
K2=	1.4

Exit

Device

The measuring devices can choose: frequency type vortex.

The number of K-factor segments

The number of K-factor segments, and one group is up to 10 segments.

K-factor unit

K-factor unit can choose: times/m³、times/L。

K factor

When the unit of K factor is times / m³, it is based on the flow formula

$$Q = f / K \cdot \rho * 3600$$

Set frequency segment K factor.

When the unit of K factor is times /L , it is based on the flow formula

$$Q = f / K \cdot \rho * 3.6$$

Set frequency segment K factor

Q unit :kg/h, f is Hz, and ρ is kg/m³。

3.5.6 SET PARAMETER OF CURRENT OUTPUT FLOWMETER

Current output type flow meter parameters set

Set the related parameters of current output flowmeter measuring device.

Configuration interface is as follows:

Setup	
Type	Electromagnetic

Exit

Device

Measuring device can choose: electromagnetic flowmeter, 4-20mA vortex.

3.5.7 ELBOW FLOWMETER

Set related parameters of elbow flowmeter measuring device.

Configuration interface is as follows:

Setup	
Sqrt	Yes
K	1.5

Exit

Square root

When the flow signal is the differential pressure signal, set the square root types of differential pressure signal which is output by the differential pressure transmitter.

- Sqrt of this instrument: when differential pressure transmitter has no sqrt and it is required to have the square root of the differential pressure signal during compensation, select this setting.
- Differential change sqrt: when the differential pressure signal of pressure transmitter has sqrt, select this setting.

K factor

Set K-factor of differential pressure segment based on the flow formula

$$Q = k\sqrt{\Delta P \cdot \rho}$$

Q unit: kg/h, ΔP unit : Pa, ρ is kg/m³.

3.5.8 MASS FLOWMETER

There is no calculation of temperature and pressure compensation , only the direct calculation of the flow rate and flow total amount.

3.6 MEDIUM CONFIGURATION

Medium configuration includes medium type, temperature, pressure, atmospheric pressure, and other relevant parameters.

3.6.1 SELECT THE MEASURING MEDIUM

Configuration location: Configuration -> medium configuration. Configuration screen is as follows:

Medium	
Type	Saturated steam
Setup	

It can choose the following 8 categories of media:

1. Saturated steam (support temperature compensation, pressure compensation)
2. Superheated steam
3. Water
4. General liquids
5. Single gas (support 18 kinds of standard gas: Air, nitrogen N_2 , oxygen O_2 , helium He, hydrogen H_2 , argon Ar, CO, carbon dioxide CO_2 , hydrogen sulfide H_2S , ammonia NH_3 , methane CH_4 , ethane C_2H_6 , propane C_3H_8 and butane C_4H_{10} , ethylene C_2H_4 , acetylene C_2H_2 , propylene C_3H_6 , butene C_4H_8)
6. General gas
7. Mixed gas
8. Artificial gas

3.6.2 SATURATED STEAM MEDIUM CONFIGURATION

Set the configuration parameter of saturated steam medium, which supports temperature compensation and pressure compensation.

Configuration interface is as follows:

Medium	
Type	T Compensation
Humidity	0%
Atm	0.101325MPa
Exit	

Mode

Saturated steam compensation can choose: temperature compensation, pressure compensation.

Humidity

Saturated steam humidity value can be set from 0% to 100% .

Atmospheric pressure

Due to geographical factors, atmospheric pressure will differ. The default is 0.101325MPa.

3.6.3 SUPERHEATED STEAM MEDIUM CONFIGURATION

Set the configuration parameters of the superheated steam medium. Configuration interface is as follows:

Setup	
Atm	0.101325MPa
Exit	

Atmospheric pressure

Due to geographical factors, atmospheric pressure will differ. The default is 0.101325MPa.

3.6.4 WATER MEDIUM CONFIGURATION

Set the parameters of water medium configuration. Configuration interface is as follows:

Setup	
Atm	0.101325MPa
Exit	

Atmospheric pressure

Due to geographical factors, atmospheric pressure will differ. The default is 0.101325MPa.

3.6.5 GENERAL LIQUID MEDIUM CONFIGURATION

Set the parameters of general liquid medium configuration . Configuration interface is as follows:

Setup		
Density	1.000	kg/m ³
SHC	4.20	kJ/kg°C
Atm	0.101325MPa	
Exit		

Density

Set general liquid density value, and fixed density value has compensation. It is suitable in the occasion where density is unchanged or changed little.

Specific heat

Set general liquid specific heat value for calorie calculation.

Atmospheric pressure

Due to geographical factors, atmospheric pressure will differ. The default is 0.101325MPa.

3.6.6 SINGLE GAS AND GENERAL GAS MEDIUM CONFIGURATION

Set parameters of single gas and general gas medium configuration. Configuration interface (expanded view) is as follows:

The single gas configuration screen

Setup		◆
Medium	C ₄ H ₈	
Humidity	0%	
Tn	20°C	
Atm	0.101325MPa	
		Exit

general gas configuration screen

Setup		◆
Humidity	0%	
Tn	20°C	
ρn	2.0 kg/m ³	
Z	1.000	
Atm	0.101325MPa	
		Exit

Media

18 standard gases can choose : Air, nitrogen N₂, oxygen O₂, helium He Hydrogen H₂ argon Ar, carbon monoxide CO, carbon dioxide CO₂, hydrogen sulfide H₂S, ammonia NH₃, methane CH₄, ethane C₂H₆, propane C₃H₈ and butane C₄H₁₀, ethylene C₂H₄, acetylene C₂H₂, propylene C₃H₆, butene C₄H₈.

Humidity

Humidity value can be set from 0% to 100%.

The temperature under the standard conditions

The temperature of the gas under standard conditions can choose : 0 °C, 15 °C or 20 °C.

The density under the standard conditions

Set the density of the general gas under standard conditions .

Compression factor

Set the compression factor of general gas.

Atmospheric pressure

Due to geographical factors, atmospheric pressure will differ. The default is 0.101325MPa.

Set the gas component

Set the mixture gas composition and percentage content. The components include 18 kinds of standard gas.

3.6.7 MIXED GAS AND ARTIFICIAL GAS MEDIUM CONFIGURATION

Set mixed gas and artificial gas medium configuration parameters. Configuration interface (expanded view) is as follows:

Setup		◆
Humidity	0%	
Tn	20°C	
Atm	0.101325MPa	
Set gas component		
		Exit

Humidity

Humidity value can be set from 0% to 100% .

The temperature under the standard conditions

The temperature of the gas under standard conditions can choose : 0 °C, 15 °C or 20 °C.

Atmospheric pressure

Due to geographical factors, atmospheric pressure will differ. The default is 0.101325MPa.

Set the gas component

Set the mixture gas composition and percentage content. The components include 18 kinds of standard gas.

3.7 FLOW CONFIGURATION

Set the related parameters of flow configuration

Location configuration: Configuration -> flow configuration. The configuration screen (expanded view) is as follows:

Flow config	
Flow Unit	t/h
Flow scale	30000
Flow com	6.00
K	1.00
B	0.00
Magnification	1
Accu init	0
Clear total flow	
Trade parameter	
Steam stop parameter	
Exit	

3.7.1 SET BASIC FLOW PARAMETERS

Flow unit

Set unit of instantaneous flow , which is involved in the operation.

Flow units: kg/h 、 t/h、 m³/h、 km³/h、 L/min、 Nm³/h、 kNm³/h。

Flow range

Instantaneous flow range is used by the curve display and transmitter output. The accuracy of instantaneous flow display is in accordance with the decimal digits.

Common flow

Common flow measuring device designs flow, which is valid for the orifice, nozzle and venturi.

Flow rate adjust K, B

Flow value linear adjustment function. The actual value = measuring value × K + B.

Accumulative magnification

Set flow accumulative magnification.

The flow total amount = last total amount+ instantaneous flow × accumulative magnification .

Accumulative initial value

Set the accumulative initial value. Perform cleaning flow total amount function, and use this value to begin to accumulate.

3.7.2 SET ADVANCED SETTLEMENT PARAMETER

Location configuration: Configuration -> flow configuration -> the advanced settlement parameter setting.

Configuration screen (expanded view) is as follows:

Setup		◆
Power down	50%	
Little flow	30%	
Over flow	200%	
		Exit

Blackout complement

After the instrument is power-down, the instrument will automatically make up the total amount of losses during the power outage after the power turns on.

The total complement flow= blackout complement percentage × flow range × outage time.

Small flow complement

Set percentage; When flow is less than the value, it will be accumulated in accordance with the complemented amount.

Overrun complement

Set percentage; when the flow exceeds the range, it will accumulate according to the complemented amount.

3.7.3 SET STEAM STOP JUDGING PARAMETER

Location configuration: Configuration -> flow configuration -> steam stop judging parameter. The configuration screen (expanded view) is as follows:

The screenshot shows a configuration screen for 'Steam stop temperature'. At the top, the title 'Steam stop temperature' is displayed. Below it, the label 'Stop T' is followed by a black rectangular box containing the value '100 °C'. At the bottom right of the screen, there is an 'Exit' button.

Steam stop temperature

This parameter is only valid for steam, and when the detected condition temperature is below the temperature of the steam stop, the valve will be fully closed and the instantaneous flow is zero.

3.7.4 CLEAR FLOW TOTAL AMOUNT

Functional position: Configuration -> flow configuration -> Clear flow total amount.

Clearing flow total amount will clear the total amount of flow in the memory. Once it is cleared, it can not be restored.

The clearing of flow total amount does not affect the other parameters and functions of the instrument.

CHAPTER 4 HEAT FUNCTION

4.1 INTRODUCTION TO HEAT FUNCTION

Based on the instantaneous flow rate and acumulative total amount after temperature and pressure compensation, combined with the measurement of heat parameters of medium physical properties, it will have real-time calculation of instantaneous heat and heat total amount.

The instrument supports calculation of superheated steam, saturated steam, water and liquid heat , and it does not support other medium heat calculation.

4.2 HEAT CONFIGURATION

Set the parameters related to the heat.

Heat config	
Heat	Yes
Heat unit	GJ/h
Heat scale	30000
Power down	0%
Magnification	1
Accu init	0
Clear total heat	
	Exit

Heat function

Set heat feature to be enabled or turned off.

Thermal unit

Set instantaneous heat unit, kJ / h, MJ / h, GJ / h, kWh / h. The units are involved in operation.

Heat range

Set the instantaneous heat range, which will be used by the curve display and the transmitter output. The display accuracy of instantaneous heat is determine by the number of decimal digits.

Blackout complement

After the instrument is power down, the instrument will automatically make up the total amount of losses during a power outage after the power turns on.

The total complemented heat = blackout complement percentage \times heat range \times blackout time.

Computing unit is the same with the instantaneous heat.

Accumulative magnification

Set the heat accumulative magnification.

The total amount of heat = last total amount + instantaneous heat \times accumulative magnification.

Accumulative initial value

Set the accumulative initial value. When performing cleaning heat total function, use this value to begin to accumulate

4.3 CLEAR HEAT TOTAL AMOUNT

Function position: Configuration -> heat Configuration -> Clear heat total amount.

Clearing heat total amount will clear the total amount of heat in the memory, and once it is cleared, it can not be restored.

The clearing of heat total amount does not affect the other parameters and functions of the instrument.

CHAPTER 5 RS485 COMMUNICATION

This instrument provides standard RS485 serial communication interface and adopts the international general standard

MODBUS - RTU communication protocol, and it support No. 03 keeping register command.

5.1 REGISTER ADDRESS LIST

Communication data and register address are in the list below:

Parameter	Type	Address	Description
Instantaneous flow	Float	40001	4-byte floating-point number. 4 byte floating point number is consistent with 4-byte long integer data in terms of byte order and the byte swapping in communication configuration. The following is similar.
Differential pressure/frequency	Float	40003	
Temperature	Float	40005	
Pressure	Float	40007	
Total amount of flow	Ulong	40009	4-byte long integer
Instantaneous heat	Float	40011	4-byte floating-point number.
Total amount of heat	Ulong	40013	4-byte long integer
Density	Float	40015	4-byte floating-point number.
The last power-down time	Ulong	40017	4-byte long integer, calendar time format
The last power-on time	Ulong	40019	4-byte long integer, calendar time format
Total power-down time (second)	Ulong	40021	4-byte long integer
The total times of power-down	Ushort	40023	Short integer
Differential pressure disconnection sign	Ushort	40024	Short integer. 0 stands for normal condition, 1 stands for disconnection.
Temperature disconnection sign	Ushort	40025	Short integer. 0 stands for normal condition, 1 stands for disconnection.
Pressure disconnection sign	Ushort	40026	Short integer. 0 stands for normal condition, 1 stands for disconnection.
System time	Uchar[8]	40027	[0-5] bytes respectively represent the year/ month/day/hour/ minute/ second
System time	Ulong	40031	4-byte long integer, calendar time format
Switching value	Ushort	40033	Short integer

Note: only to provide communication interface of real-time data, not to contain the history data, accumulative report and other data.

Calendar time begin on January 1st, 0: 0 :0 , 1970.

5.2 CONNECTION MODE

Terminal name

RS485 communication interface terminals are A and B, G, and their corresponding terminal serial numbers are 14, 15, 16.

As for the specific mode of connection, please refer to the section 【1.4 instrument wiring】.

Connection mode

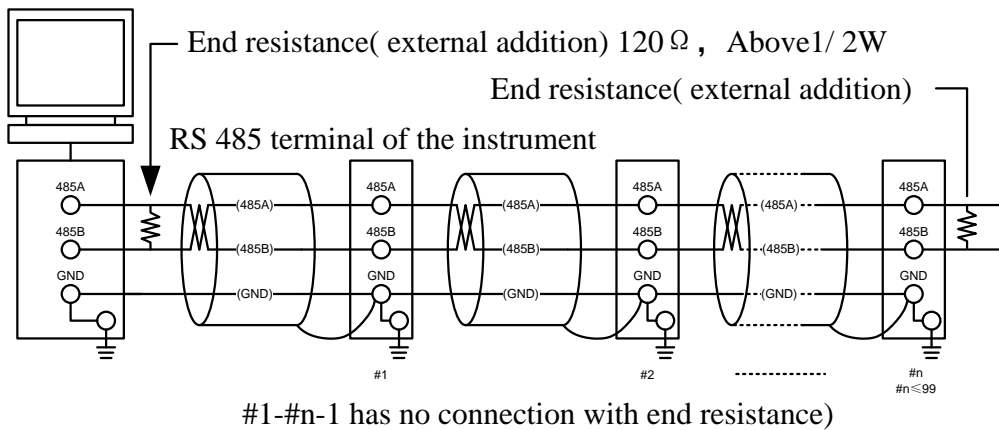

Communication specification

Item	Content
Baud rate	1200/2400/4800/9600/19200/38400/57600
Data format	8 data bits , 1 stop bit
Parity	Odd parity/even parity/no parity

5.3 COMMUNICATION CONFIGURATION

Set communication configuration parameters.

Configuration location: configuration - > function configuration - > communication, and the configuration screen is as follows:

Com config		◆
Address	001	
Baud rate	9600	
Parity	None	
Swap	No	
		Exit

Instrument address

Setting communication instrument address, 1-247 (optional).

Baud rate

Optional: 1200/2400/4800/9600/19200/38400/57600.

Parity

Optional: no parity/odd parity/ even parity .

Byte exchange

Optional: no exchange or exchange. Arrange it according to the 32-bit data (long plastic or floating point number) in communication frame. Example:

Long plastic 01020304 H: no exchange: 03 04 01 02 exchange: 01 02 03 04

Floating point number 4.00 (0x40800000H) no exchange: 00 00 40 80 exchange:
40 80 00 00

CHAPTER 6 ANALOG TRANSMITTER OUTPUT

6.1 TRANSMITTER OUTPUT SPECIFICATION

This instrument provides 1 road 4-20 mA analog transmitter output function.

It can be transmitted output according to instantaneous flow, heat, differential pressure, temperature, pressure.

Analog output load is less than 750 Ω .

As for the connection methods, please refer to the section **【1.4 instrument wiring】**.

6.2 OUTPUT CONFIGURATION

Configuration location: configuration - > function configuration - > output, and the configuration screen is as follows:

Output config		
Output		Flow
K	1.000	(mA)
B	0.000	
		Exit

Output channel

Set output source channel, optional: flow, heat (open), differential pressure, temperature, pressure.

According to the range, it can have transmitting output operation.

Adjustment K, B

Linear adjustment outputs current. The actual output current = operation output current \times K + B.

CHAPTER 7 CHANNEL ALARM

7.1 ALARM AND CONFIGURATION

This instrument has the channel high alarm and low alarm function, and it supports 1 road alarm relay contact output and saves the latest 50 alarm information, including alarm time, cancellaion alarm time, alarm type and alarm channel.

Configuration location: configuration - > function configuration - > alarm, and the configuration screen is as follows:

Alarm config			
Chnl	Flow		
H	60000	Relay	00
L	0	Relay	00
Zone	0		Exit

Channel

Choose alarm channel, flow rate, temperature, pressure (optional).

Alarm H, alarm L

Set parameter value of high alarm and low alarm.

Contact

Road contact output is optional, and its capacity is 250 VAC/ 3 A, 30 VDC / 3 A (impedance load). The contact type is normally open. Multiple channel alarm can share contact together.

Hysteresis

Set alarm hysteresis parameter to prevent frequent alarm when signal has oscillation when it is near the alarm value.

Alarm description

Alarm type	Alarm condition	Condition for alarm cancellation
High alarm	Channel value > high threshold channel value	Channel value < high threshold channel value - hysteresis
Low alarm	Channel value < low threshold channel value	Channel value > low threshold channel value + hysteresis

7.2 ALARM LIST SCREEN

Screen location: function screen - > alarm list, display the latest 50 alarm information.

Alarm list	01/50
Time	10-10-20 10:30:00
Alarm	on
Type	L
Chnl	Flow

Operation

Use **【Increase】** **【Decrease】** key to query alarm information.

Use **【Page】** key to exit the screen.

7.3 CLEAR ALARM LIST

Function location: configuration - > function configuration - > system - > clear alarm list.

Clear alarm record information in the memory , and once it is cleared, it is unable to restore.

Clearing alarm list does not affect other parameters and function of the instrument.

CHAPTER 8 HISTORY DATA

The instrument will have real-time storage of measurement data and operation data, and write it to internal storage.

8.1 RECORDING FUNCTION AND CONFIGURATION

According to recording interval parameters, the instrument will timely save flow, differential pressure, temperature, pressure, flow total amount, quantity of heat, heat total amount (when heat function is enable) to internal storage.

Record interval is optional: 1 minute / 2 minutes / 5 minutes / 10 minutes / 20 minutes / 30 minutes / 60 minutes.

Record duration: 1 minute recording interval can continuous recording for a month.

Note

- Increasing record interval can prolong the length of time of storage data.
 - Modifying record interval can make the historical data stored in the instrument invalid, and therefore, before the modification of record interval, please back up historical data to prevent loss.
-

Configuration location: configuration - > function configuration - > system - > record interval.

Configuration screen is as follows (expansion plan) :

System config 	
Date	2010-10-20
Time	10:05:00
Interval	01Min
Meter No.	A001
Clear alarm list	
Clear his data	
Clear accu report	
Clear shut list	
Factory setting	
Exit	

8.2 HISTORY DATA QUERY SCREEN

Historical data have two kinds of form, trend and data list . As for history trend screen, please refer to **【1.5.3 section】** .

The historical data screen location: function image - > history data, supporting inquiry of flow, heat, differential pressure, temperature, pressure, flow amount and total amount of heat history data.

When the instrument is power down and has no history data, it will display - - - - .

Continuous searching

Hisdata	
Interval	01M
Time	10-10-20 11:00
Chnl	Flow
Data	0.113

Fixed-point searching

Hisdata	
Interval	01M
Time	10-10-20 11:00
Chnl	Flow
Data	0.113

Channel switching

Use **【Increase】【Decrease】** to switch channel: flow, heat, temperature, pressure, differential pressure, flow amount, total amount of heat.

Continuous searching

Use **【Left】【Right】** key to have continuous adjustment of searching time to go through the historical data.

Fixed-point searching

Use **【Enter】** key to enter fixed-point searching mode, and time is editable.

Use **【Increase】【Decrease】** key to modify time, and press [Enter] key to view history data.

It will automatically switch to continuous searching mode at that time

8.3 CLEAR HISTORY RECORD

Function location: configuration - > function configuration - > system

Clear history data record in the memory , and once it is cleared, it will be unable to restore.

Clearing historical records does not affect other parameters and function of the instrument.

CHAPTER 9 ACCUMULATIVE REPORT

9.1 ACCUMULATIVE REPORT FUNCTION AND CONFIGURATION

Instrument supports both flow accumulative report and heat accumulative report, and it provides monthly accumulative report and shift report these two kinds (does not support coexisting of these two kinds reports).

Annual and monthly report: save monthly accumulative total amount within recent 2 years, and save daily accumulative amount within latest 24 months.

Shift report: save the accumulative shift report within recent 2 months.

Configuration location: configuration - > function configuration - > report, and the configuration screen is as follows:

Report config	
Type	Annual-Monthly
Settlement time	0hour
Exit	

Report config	
Type	Shift
Shift time	0hour
Shift	8 hour
Exit	

Type

Optional : Yearly and monthly report and shift report. It will permanently clear the original report data. If it changes the report type.

Settlement time

It is effective to monthly report. For example, settlement time 1 hour, and it will settle accumulative amount from the 1 hour o'clock that day to the second day 1 hour.

Times of shift report

It is valid for shift report, 0 ~ 12 hour can be set.

The time length of shift report

It is valid for shift report, 8 hours, 12 hours (optional).

9.2 ACCUMULATIVE REPORT QUERY SCREEN

Screen location: function screen - > accumulative report

Report query supports yearly and monthly report, shift report and time query.

Report		
Type	Flow	
Data	Annual	Monthly

Report		
Type	Heat	
Data	Shift	

Operation:

Use **【Left】** **【Right】** key to move the cursor.

Use **【Increase】** **【Decrease】** key to select flow report or heat report.

Use **【Enter】** key to query relevant report.

Use **【Page】** key to exit this screen.

9.2.1 YEARLY REPORT SCREEN

Accumulative yearly report shows monthly flow accumulative report within recent 2 years.

2011	t
2011-01	1200.00
2011-02	1000.00
2011-03	800.00
2011-04	900.00

Operation

Use **【left】** **【right】** key to switch the year of report

Use **【Increase】** **【Decrease】** key to query report data.

Use **【Page】** key to exit this screen.

9.2.2 MONTHLY REPORT SCREEN

Accumulative monthly report shows the daily flow report within the past 12 months.

2011-12	t
11-12-01	100.00
11-12-02	200.00
11-12-03	150.00
11-12-04	120.00

Operation

Use **【Left】** **【Right】** key to switch months of report.

Use **【Increase】** **【Decrease】** key to query report data.

Use **【Page】** key to exit this screen.

9.2.3 SHIFT REPORT SCREEN

Class statements picture Accumulative shift report shows the every shift flow report within recent two months.

2011-12	t
01 110.00	105.00 100.00
02 195.00	200.00 205.00
03 155.00	150.00 150.00
04 110.00	120.00 130.00

Operation

Use **【Left】** **【Right】** key to switch months of report.

Use **【Increase】** **【Decrease】** key to query report data.

Use **【Page】** key to exit this screen.

9.3 CLEAR ACCUMULATIVE REPORT

Function location: configuration - > function configuration - > system - > clear accumulative report

Clear the flow and heat accumulative report in the memory, and it is unable to be restored after clearing.

Clearing accumulative reports does not affect other parameters and function of the instrument.

CHAPTER 10 POWER-DOWN RECORD

10.1 POWER-DOWN RECORD FUNCTION

Save the latest 50 power-down records, including power-down time, power-on time, the power-down duration and total power-down duration. The power-down resolution time is 1 minute.

10.2 POWER-DOWN RECORD QUERY SCREEN

Screen location: function screen -> power-down record, and it will display the latest 50 power-down records.

Shutlist	01/40
On	10-10-20 08:30:00
Off	10-10-20 09:00:00
Time	0D0H30M0S
All	9D20H1M30S

Operation

Use **【Increase】** **【Decrease】** key to query power-down record.

Use **【Page】** key to exit this screen.

10.3 CLEAR POWER-DOWN RECORD

Function location: configuration -> function configuration -> system -> clear power-down record

Clear power-down record in the memory of the instrument, and it is unable to be restored after clearing.

Clearing power-down record will not affect other parameters and function of the instrument.

CHAPTER 11 SYSTEM LOG

11.1 SYSTEM LOG FUNCTION

Save recent 50 system operation log.

Operation log includes operation of content and operation of time.

Record the following operation types:

- Modify configuration parameters
- Modify flow accumulative magnification
- Modify heat accumulative magnification
- Clear total amount of flow
- Clear total amount of heat
- Modify record interval

11.2 SYSTEM LOG QUERY SCREEN

Screen location: function screen - > system log, and it will show the latest 50 system logs.

Log	01/50
Type	Modify Config
Time	10-10-20 10:40:00

Operation

Use **【Increase】** **【Decrease】** key to query operation log.

Use **【page】** key to exit this screen.

CHAPTER 12 DOUBLE PASSWORD PROTECTION

12.1 DOUBLE PASSWORD PROTECTION FUNCTION

Instrument has dual password protection function, namely, use the passwords of both sides to protect the configuration parameters. That is to say, it must provide the password of both sides to enter configuration interface and to set parameters.

12.2 PASSWORD SETTING SCREEN

Screen location: function screen- > password revise.

In the process of modifying password, it needs to enter the original password, and then enter a new password after confirming.

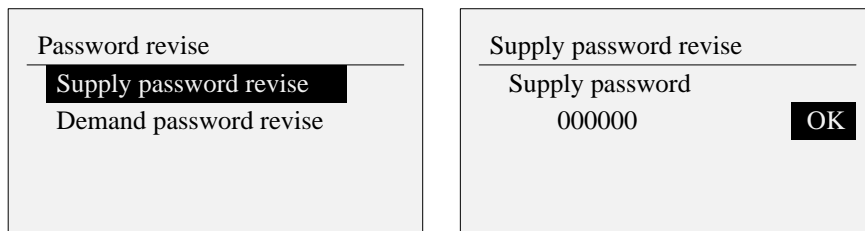

Operation

- Use **【Left】** and **【Right】** key to move the cursor.
- Use **【Increase】** **【Decrease】** key to input password.
- Use **【Enter】** key to execute the cursor corresponding function.
- Use **【Page】** key to exit this screen.

CHAPTER 13 SYSTEM CONFIGURATION

Configuration location: configuration - > function configuration - > system, and the configuration screen(expanded view) is as follows:

System config	
Date	2010-10-20
Time	10:05:00
Interval	01Min
Meter No.	A001
Clear alarm list	
Clear his data	
Clear accu report	
Clear shut list	
Factory setting	
Exit	

13.1 DATE AND TIME

Set the current operational date and time in the instrument.

Note

- After changing the system date/time, the history data which has been stored in the instrument will be invalid.
 - New effective data starts from the date/ time when user changes the system.
 - Before changing the system date/time, please back up the records of history data in the instrument.
-

13.2 INSTRUMENT NUMBER

Set instrument Number to distinguish the instruments used in different situations.

A total of four numbers, each group can be 0-9 and the letters from A to Z.

It will display in the title bar of the middle parameter screen.

13.3 RESTORE FACTORY SETTING

Restore all parameters and data of the instrument to factory state.

Note

- After factory settings, the history data which has been stored in the instrument will be invalid.
 - Before factory setting, please back up records of historical data in the instrument
-

Parameter list affected by factory setting

Kinds of parameters	Parameter name	Setting value of parameters		
Device configuration	Type	Standard orifice		
	Device	Flange pressure orifice plate		
	Sqrt	Sqrt of this instrument		
	Piple material	20 steel		
	Orifice plate material	1Cr18Ni9Ti		
	Pipe diameter	0mm		
	Orifice plate diameter	0mm		
Medium configuration	Type	Superheated steam		
	Atmospheric pressure	0.101325MPa		
Input configuration	Channel	Differential pressure	Temperature	Pressure
	Mode	input	input	input
	Type	4-20mA	Pt100	4-20mA
	Unit	kPa	°C	MPa
	Range	0.00~50.00	0.0~300.0	0.00~1.60
	Cutting	0.0%	0.0%	0.0%
	Filter	0.0 second	0.0 second	0.0 second
	K	1.00	1.00	1.00
	B	0.00	0.00	0.00
	Disconnection complement	0.00	0.00	0.00
Flow configuration	Flow unit	t/h		
	Flow range	0		
	Common flow	0		
	Flow adjustment K	1.00		
	Flow adjustment B	0.00		
	Accumulative magnification	1		
	Accumulative initial value	0		

	Power-down complement	0%
	Small flow complement	0%
	Overrun complement	0%
	Steam stop temperature	0
Heat configuration	Heat function	Closed
	Heat unit	GJ/h
	Heat range	0
	Power-down complement	0%
	Accumulative magnification	1
	Accumulative initial value	0
System configuration	Password	000000
	Recording interval	01 minute
	Instrument number	A001
Alarm configuration	Alarm H	60000
	Contact	00
	Alarm L	0
	Contact	00
	Hysteresis	0
Output configuration	Output channel	None
Communication configuration	Communication address	001
	Baudrate	9600
	Parity	No parity
	Byte exchange	No exchange
Screen configuration	Display interval	10 seconds

CHAPTER 14 USB DATA BACKUP

14.1 DATA BACKUP FUNCTION

Instrument has the function of data backup. It will back up the internal data to the USB flash drive, using a key backup.

The data backup includes history data, accumulative report (accumulative annual report, accumulative monthly report or accumulative shift report) power-down records, alarm record, operation log.

The format of backup data uses CSV file format, which can be viewed some spreadsheet software, e.g Excel.

14.2 DATA BACKUP SCREEN

Screen location: function screen - > data backup.

Back up data to backup directory folder of USB flash disk, e.g. /USB/DATA/03141645, a folder is named month/ day/ hour/ minute.



Operation

Use **【Enter】** key to back up data.

Use **【Page】** key to exit this screen.

CHAPTER 15 CONFIGURATION BACKUP

15.1 CONFIGURATION BACKUP FUNCTION

Instrument has configuration backup function, and it will back up instrument configuration data to the usb flash drive, using a key backup.

Backing up data uses CFG binary files, and the instrument uses the file to back up and import operation.

Backing up will also generate CSV files, which can use the Excel software to view.

15.2 CONFIGURATION BACKUP SCREEN

Screen location: configuration - > function configuration - > configuration.

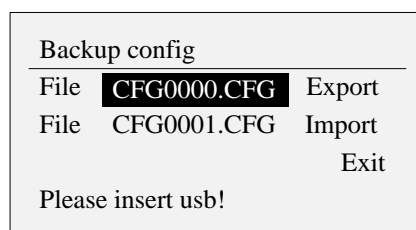

Operation

Use **【Left】** **【Right】** key to move the cursor.

Use **【Enter】** key to execute cursor corresponding function.

Configuration export

Back up configuration to the root directory of USB flash drive

Use **【Increase】** **【Decrease】** key to select file, CFG0000~CFG9999(optional).

Configuration import

Insert the USB flash drive to automatically find configuration file under the USB flash drive root directory.

Use **【Increase】** **【Reduce】** key to select configuration file.

CHAPTER 16 SPECIFICATION

16.1 SIGNAL, DISTRIBUTION AND ALARM

Signal

Item	Channel		
The number of input channle	3channel		
Measuring period	1 second		
Signal type	Type	Type	Measuring range
	DC current	4 - 20mA	4.00 ~ 20.00mA
	Frequency	FR	0.0 ~ 10000.0Hz
	Thermal resistance	PT100	-50.0℃ ~ 650.0℃
PT1000		-50.0℃ ~ 250.0℃	
Transmitter output	DC current	4 - 20mA	4.00 ~ 20.00mA

Power distribution

Item	Specification
Distribution voltage	3-road 24VDC \pm 10%, 1-road 12VDC \pm 10%
Output current	\leq 30mA
other	differential pressure and pressure distribution ground together

Alarm

Item	Specification
Alarm channel	Flow rate, temperature, pressure,
Alarm type	High alarm, low alarm
Display	When alarm occurs, the alarm status is displayed on a digital display screen.
Alarm record	Save the lastest 50 alarm
Contact capacity	250VAC/3A, 30VDC/3A(resistive load), contact type is normally open

16.2 DISPLAY SPECIFICATION

Display

Item	Specification
display*	128×64 dot matrix monochrome LCD display

*LCD display section may contain pixels of continous ON or OFF . Due to the the different LCD characteristics, the brightness of the LCD may not the same, but this is not a malfunction.

16.3 GENERAL SPECIFICATION

Performance standards

Item	Specification
Display / measurement accuracy	Numerical precision: basic error of the whole range \leq 0.2%F.S.
Input impedance	Current signal: 10 Ω
Resistance measuring excitation current	0.25mA
Burnout detection current	About 1uA
The largest common mode noise voltage	250VACrms(50Hz)

Power supply

Item	Specification
Rated power supply voltage	220VAC/24VDC
Allowable voltage range	85VAC \sim 220VAC / 22VDC \sim 26VDC
Rated power frequency	50Hz
Power consumption	\leq 10W

Structure

Item	Specification
Installation	The embedded dashboard Installation (vertical)
Mounting angle	Allows a maximum inclination of 30 degrees from the horizontal plane
Mounting plate thickness	2 \sim 12mm
Material	ABS plastic
External dimensions	160(W) \times 80(H) \times 68(D)(D: the length from the mounting surface to the terminal)
Weight	About 0.5Kg

Standard operating conditions

Item	Specification
power supply voltage	220VAC/24VDC
Power supply frequency	50Hz
Environment temperature	0°C ~ 50°C
Environment humidity	0% ~ 85%(no condensation)
Warming-up time	30 minutes after the power is turned on
Installation location	Indoors

Transportation and storage condition

Item	Specification
Environment temperature	-10°C ~ 60°C
Environment humidity	0% ~ 95%(no condensation)

Clock

Item	Specification
Clock	Run from 2000 year to 2099 year
Clock accuracy	± 10ppm(0 ~ 50°C), not including the delay error caused when the power is turned on (less than 1 sec)
Clock battery usage	About 10 years (under room temperature)

Other standard

Item	Specification
Data retention time	About 10 years

APPENDIX 1 COMMON GAS DENSITY IN STANDARD CONDITION

Air (dry):1.2041	Nitrogen:1.1646	Oxygen:1.3302	Helium:0.1664
Hydrogen:0.0838	Krypton:3.4835	Methane:0.6669	Ethane:1.2500
Propane:1.8332	Ethylene:1.1660	Propylene:1.7495	CO:1.165
Carbon dioxide:1.829	Hydrogen sulfide:1.4169	Sulfur dioxide:2.726	

(20°C, Standard atmospheric pressure, unit: kg/m³)

APPENDIX 2 EXAMPLES OF STANDARD ORIFICE CONFIGURATION

Standard orifice plate design book					
Cutting pieces	Standard orifice	Pressure taken mode	Corner connection pressure ①	Fluid name	Saturated water vapor ②
The form of the the throttling element in the upstream: a single 90 ° elbow, two 90 ° elbows on any surface (S>30D)					
Process conditions					
Maximum flow	300.00kg/h③	Common flow	275.00kg/h④	Minimum flow	250.00kg/h
Working pressure	0.60000MPa	Working temperature	164.95℃	Working density	3.66617kg/m ³
Regional atmospheric pressure	1000mbar ⑤	Pipe	φ 57×3.5mm ⑥	Fluid viscosity	0.01451mPa.s
Isentropic index	1.29640	Absolute roughness 0.075			
Pipe material	10# ⑦	Linear expansion coefficient	0.00001212mm/mm℃		
Materials of cutting pieces	1Cr18Ni9Ti ⑧	Linear expansion coefficient	0.00001700mm/mm℃		
Calculation coefficient					
Scale flow	300.00kg/h	Differential pressure on the line Δ Pmax	10000Pa ⑨		
Maximum pressure loss	300.00kg/h	Differential pressure on the line Δ Pcom	8402Pa		
Opening hole ratio β	0.499414	Discharge coefficient C	0.608513	Expansion coefficient ε	0.996565
Maximum Reynolds number	146017	Common Reynolds number	133849	Minimum Reynolds number	121680
Calculation error E	0.000007%	Flow uncertainty e	± 85%	Flow factor α	0.628372
Front straight pipe L1	1.10m	Latter straight pipe L2	0.30m	Opening hole in working condition d	25.015mm
20℃, openings of cutting pieces d20		24.953±0.012mm ⑩			
Formula	$M=0.003998595 * d^2 * \epsilon * \alpha (\Delta P * \rho)^{0.5} \text{kg/h}$				

The instrument configuration is as follows:

1、 Device configuration			2、 Medium configuration	
Device type	Corner pressure orifice plate ①		Mode	Saturated steam ②
Sqrt	Sqrt of the instrument		Type	Temperature compensation
Pipe material	10 steel ⑦		Atmospheric pressure	0.1MPa ⑤
Orifice plate material	1Cr18Ni9Ti ⑧			
Pipe diameter	50mm(57-3.5*2) ⑥			
Orifice plate diameter	24.953mm ⑩			
3、 Input configuration			4、 Flow configuration	
Differential pressure	Mode	Input	Flow unit	kg/h ③
	Type	4-20mA	Total amount unit	kg
	Unit	Pa ⑨	Flow range	300 ③
	Range	0-10000.0 ⑨	Common flow	275 ④
Temperature	Mode	Input		
	Type	PT100		
	Unit	℃		
	Range	0-300		
Pressure	Mode	Calculation		

APPENDIX 3 EXAMPLE OF FREQUENCY VORTEX CONFIGURATION

Vortex nameplate information			
Nominal pressure	1.6MPa	Highest temperature	300°C
Instrument factor	67.14	Unit	1/m ³
Accuracy	First class	Full scale flow	60m ³ /h

Instrument configuration is as follows:

1、 Device configuration			2、 Medium configuration	
Device type	Frequency vortex		Type	superheated steam
K factor	67.14		Atmospheric pressure	0.101325MPa
K factor unit	Times /m ³			
3、 Input configuration			4、 Flow configuration	
Frequency	Mode	Input	Flow unit	m ³ /h
	Type	Fr	Total amount unit	m ³
	Unit	Hz	Flow range	80
	Range	0-3000		
Temperature	Mode	Input		
	Type	PT100		
	Unit	°C		
	Range	0-300		
Pressure	Mode	Input		
	Type	4-20mA		
	Unit	Mpa		
	Range	0.00-1.60		
